



isocindu

BUILDING ENVELOPE SOLUTIONS

Cindu - Manni Group J.V.

General Catalog







Index

About Us

Who we are & What we do	4
Industries Served	6
Insulation Core	7
Leaf - New Technology	8
Certifications and Associations	9
Factory Mutual Certificate	10
Isocindu fo LEED Certification	11
Fire & Acoustic Certificates	13
Finishes and Colors	15

Roof Panel

Isocop	17
Isodeck PVSteel / TPO	19
Green Roof	21

Wall Panel

Isoparete	23
Isobox & Super Isobox	25

Mineral Wool Panel

Isopan production in Europe

Isofire Roof	27
Isofire Roof Fono	29
Isofire Wall	31
Isofire Wall Fono	35
Antibacterial Steel	37
USDA Steel	38
Stainless Steel	39
Panel Thickness Calculation	41
Portfolio	43



International leaders with the power of a group



Isocindu is the result of the partnership of two large industrial groups, Manni Group from Italy through its subsidiary Isopan a world leader in IMP manufacturing with 6 facilities throughout Europe, and Cindu of Venezuela, with several operations in America dedicated to the marketing of roofing systems.

We operate the most technologically advanced and fully automated manufacturing facility in the Americas serving the commercial, architectural, agricultural and cold storage industries with polyisocyanate, polyurethane and mineral wool panels. With over 40 years of experience behind Isocindu, we're recognized as the Americas leader in design, innovation and manufacturing of IMP's.

Our plant develops and manufacture IMP systems that guarantee more efficiency, innovation and safety to any building, with thicknesses ranging from 1" to 8" and a high R-value, the perfect thermal insulation and soundproofing.

The quality of our products is supported by a trained and qualified group of technical professionals that work with our customers to engineer and design their buildings specs and requirements.

Isocindu's main mission is to supply the construction market with technological innovation applied to IMP's and guarantee efficient logistics and service in the most sustainable way from an environmental, social and economic point of view.

► Production Technology

- Isopan's Know-how with 40 years of experience
- 2,000,000 m² of capacity per year
- High speed shift typology
- Controlled foam injection that avoids caves inside
- 20 year pioneers using cyclopentane
- Nimble and precise cured of PUR and PIR foam

► Quality and Certifications

- High quality standards in materials and suppliers
- ISO quality certification
- FM approved (4880, 4881, 4471)
- Rigorous lab quality control

► Professional technicians

- Trained professionals for product consulting
- Highly specialized installation technicians
- Skilled specifiers

► On-time logistics

- Solid and rigorous delivery structure
- Maximum speed in national and export deliveries
- Ideal geographical location for timely coverage



SEVERAL MARKETS A UNIQUE BRAND



Manni Group HP - Verona, Italy



Isopan Est - Popești Leordeni, București, Romania



Isopan Spa - Frosinone, Italy



Isopan Deutschland - Halle (Saale), Germany



Isopan Spa - Verona, Italy



Isopan Rus - Volgograd, Russia



Isopan Iberica - Tarragona, Spain



Isocindu - Silao, Mexico

INDUSTRIES SERVED

► Cold Storage

IsoCindu offers a wide range of options in panels that can deliver top performance in positive and negative cold rooms, temperature-controlled areas and clean rooms. In addition to their excellent performance, IsoCindu panels lead to an excellent hygiene level thanks to easy cleaning and washable prepainted surfaces, unsuitable for the proliferation of fungi, bacteria and mold.



► Agriculture / Farming / Grow Rooms

Thanks to their high thermal insulation, resistance to mold, acids and mechanical movements, IsoCindu panels guarantee hygiene and safety for the farming or poultry sector and are environmentally integrated with the rural area in which they are located.



► Industrial

IsoCindu panels are lightweight, safe, easy to install and provide the thermal insulation needed for buildings such as warehouses and industrial buildings, the ideal sustainable design for industry.



► Commercial / Health Care

Versatility, originality in design, safety, thermal insulation and easy assembly. The panel adapts to the different requirements of commercial buildings, allowing the maximum value of the commercial concept and brand to be projected.



► Architectural / Design

New trends in construction can be adapted with IsoCindu panel systems. High technological performances are combined with aesthetic quality to offer more advantages in a single solution.



► Residential

IsoCindu guarantees functional solutions for residential buildings of all styles, providing thermal insulation properties, safety, aesthetic value, respect for the environment, and the architectural landscape.

INSULATION CORE

PUR Foam

The expanded polyurethane has the ideal performance in thermal insulation, as well as high resistance, due to the chemical reaction between isocyanate and polyol, generating an expansion of material and filling the cells with gas, this achieves a temperature insulation and improves energy efficiency by reducing CO2 derived from heating and air conditioning equipment.



PIR Foam

PIR (Polyisocyanurate) foam, or so-called class 1, is a mixture of polyol, isocyanate and cyclopentane. It is a system for the manufacture of panels for construction and refrigeration.

This type of foam has high fire resistance, low smoke emission, delays fire spread and maintains its insulating thermal conductivity.



Mineral Wool

Mineral wool is one of the materials with the best performance in terms of fire resistance, one of the first choices when it comes to insulation and used as passive fire protection.

Is characterized by a low thermal transmittance value and therefore provides excellent insulation, but the feature that most distinguishes it from other highly insulating materials is precisely its natural incombustibility and sound absorption.

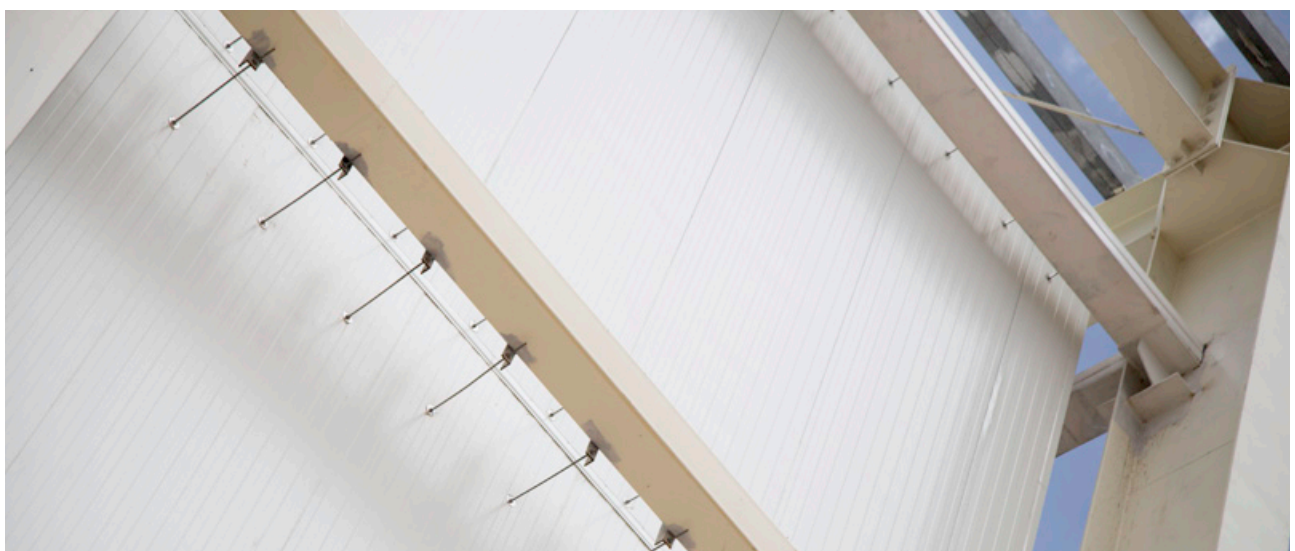

LEAF TECHNOLOGY

The most advanced insulation technology

What is LEAF?

LEAF is the most advanced technology that summarizes all of the IsoCindu approach as a whole. LEAF is the IsoCindu technology applied to insulation formulas and provides important properties to wall and roofing panels, while contributing towards obtaining credits for the LEED (Leadership in Energy and Environmental Design) certifications.

+20% Thermal Insulation

The LEAF solution improves the thermal performance of the isolating material, in particular by reducing the thermal conductivity value of the polyurethane foam. With the same thickness, it is possible to obtain lower thermal transmittance compared to a standard product.

B-s1, DO Certification

LEAF technology has obtained the maximum reaction to fire certification in Europe for polyurethane panels, called B-s1, d0. The achievement of the "s1" performance is particularly meaningful and important for polyurethane panels, since it attests to the absence of fumes originating from exposure of foam to fire.

Halogen-free Components

Fame retardants used to improve the fire resistance are made from halogenated compounds, potentially harmful to the environment. LEAF technology ensures high performance in fire behavior without using halogenated flame retardants. The excellent performance of LEAF insulation foam gives lower energy consumption with the resulting reduction of CO2 emissions.

Lower costs

This is a driver of great importance for professionals who want to create an efficient project that will appeal to the end customer. Higher thermal efficiency means less energy waste and, consequently, less consumption.

More quality

The B-s1, d0 certificate guarantees the absence of smoke in case of fire. In contact with the foam, the flames will not create smoke, which is one of the main causes of death in this type of event. This level of safety offers the design engineer and the owner greater safety compared to other solutions, guaranteeing buildings of better quality.

An interesting investment

LEAF products lead to credits for LEED and BREEAM certifications. A building with these features is certainly a much more interesting investment for design engineers, who can offer a sustainable and environmentally friendly product. These certifications guarantee higher value than the average classic building, making this all very attractive to invest in.

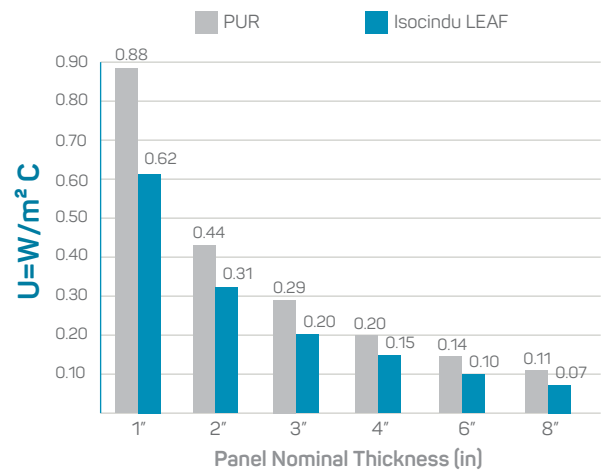
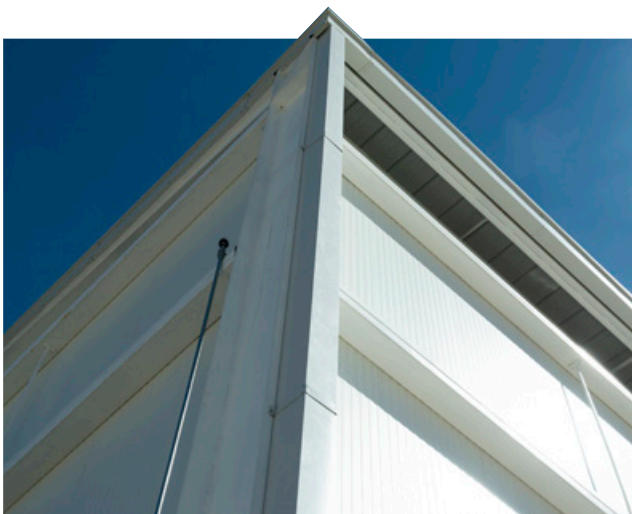

CERTIFICATIONS AND ASSOCIATIONS

Technology and Sustainability

We have a new-generation plant, which ensures a product of unbeatable quality that meets the toughest specifications and the best delivery times in the market.

IsoCindu uses a process that has been replacing chlorofluorocarbons for more than 20 years with cyclopentane, an expanding agent that evaporates at the end of the expansion process without harming the atmosphere.

- ▶ **Food grade**
- ▶ **Non-toxic**
- ▶ **Chemically inert**
- ▶ **Antistatic**
- ▶ **Flexible**
- ▶ **Phthalate Free**
- ▶ **Washable**
- ▶ **Less Maintenance**

Associations

Certifications are the first commitment we make to our customers. We work with certified suppliers, who guarantee the quality of primary materials according to international standards.

Certified under ISO 9001, using technical product equality, active member of Global Cold Chain Alliance and main promoter of safety and quality in the refrigeration industry.



Certifications

Insulated Panels:

- ASTM E28: Flame Speed 25 or less
- ASTM E28: Smoke Speed 450 or less
- ASTM C518: Thermal Transmission
- ASTM D1929: Ignition Properties
- ASTM E283: Air leakage through exterior
- ASTM E331: Water penetration
- ASTM D1623: Tensile adhesion properties
- ASTM E72: Transverse load positive and negative pressure
- ASTM E661: Roof punching shear resistance
- ASTM C272: Density water absorption
- ASTM C393: Coefficient of expansion for core and facing
- ASTM E108: fire roof classification
- FM 4471: Class A Fire Rating
- FM 4471: Class 1-SH Severe Hail Damage
- FM 4471: Wind Uplift Approvals
- FM 4880: Class 1 fire Rating
- FM 4881: Class 1 Ext Wall System

Certified EPD (environmental Product Declaration):

- Program operator: UL Environment
- Declaration number: 13CA27321.101.1
- Declared product: Insulated Metal Panels
- Reference PCR: Insulated Metal Panels & Metal Composite Panels, and Metal Cladding: Roof and Wall

ICC Certification:

Certificate pending, please contact your sales rep for more information.

Skin Delamination:

No skin delamination with direct pull off pressure up to 1188 psf



Certifications

Standards

Approval standard for class 1 fire rating of building panels or interior finish materials

4880

Approval standard for class 1 exterior wall

4881

Approval standard for class 1 panel roofs

4471

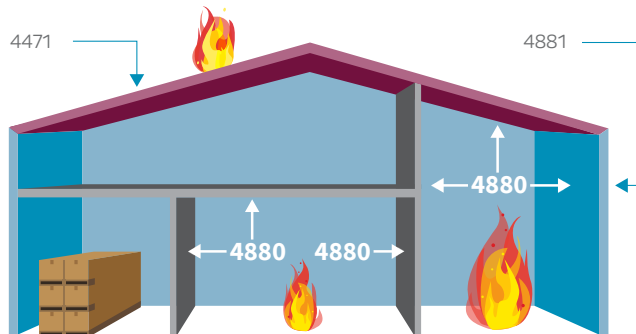

Building insulations - wall and ceilings (FM approval class numbers 4411, 4651, 4880, 4881, 4882)

A U.S. ESR or Canadian ESL report can be provided on request for additional certifications

Examination and test

Number	Section	Description
4880	4.1	Room Test
4880	4.2	Flammability Characterization
4880	4.3	16ft High Parallel Panel Test
4880	4.6	Density of Insulating Cores
4880	4.9	Ignition Properties
4880	4.10	Heat Content
4880	4.11	Ash Content
4881	4.1	Wind Pressure Rating
4881	4.3	Hail Resistance Rating
4471	4.1	Combustibility below the Roof Deck
4471	4.2	Combustibility above the Roof Deck
4471	4.3	Wind Uplift Resistance
4471	4.4	Foot Traffic Resistance Test
4471	4.5	Hail Damage Resistance Test



ISOCINDU FOR LEED CERTIFICATION

Our contribution to the efficiency and sustainability

Our contribution to the efficiency and sustainability of buildings

IsoCindu contributes to the global challenge to improve the building sector based on an environmental sustainability perspective. Efficiency and energy savings guide IsoCindu's production management.

LEED BD+C (Building Design and Construction) V4

Created in the United States by the U.S. Green Building Council (USGBC), LEED® (Leader in Energy Efficiency and Sustainable Design) is a voluntary certification system for the management, design and construction of the world's most widespread social, environmental, economic and well-being aspects for users involved in the design and construction management of buildings, both commercial and residential.

LEED certification is linked to the measurement of the following features:

IsoCindu contributes to the global challenge to improve the building sector based on an environmental sustainability perspective. Efficiency and energy savings guide IsoCindu's production management.

- ▶ Water and energy resource consumption efficiency and the use of clean energy.
- ▶ Waste management and building materials used in the production and maintenance of the building.
- ▶ The quality of the building's interior environment.
- ▶ Space building optimization and environmental impact.
- ▶ Innovation and design, such as technologies and construction models used in building construction.

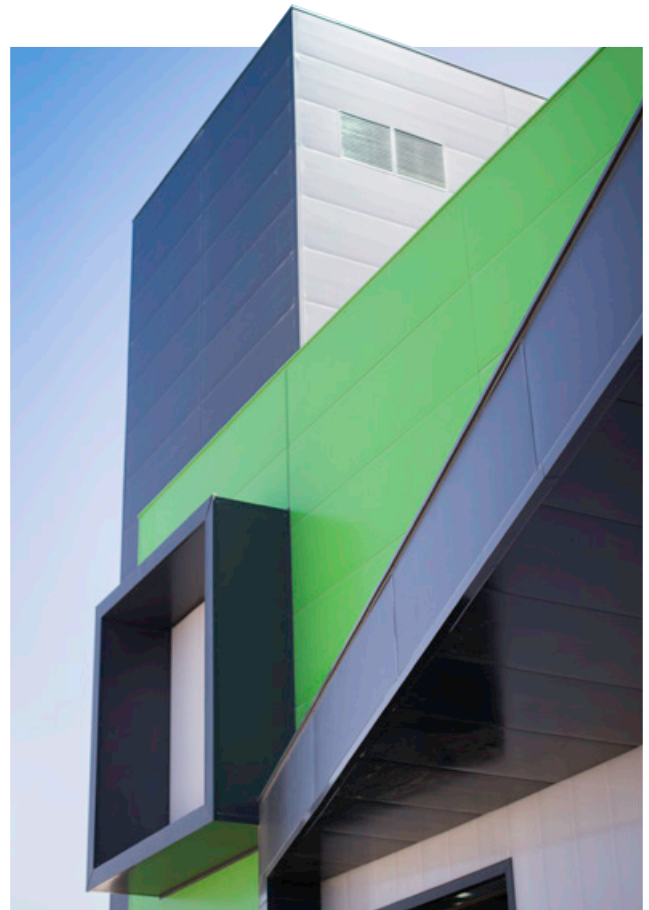

INTEGRATIVE PROCESS

IP



SUSTAINABLE SITES

SS



ENERGY AND ATMOSPHERE

EA



MATERIALS AND RESOURCES

MR



INDOOR ENVIRONMENTAL QUALITY

EQ



ISOCINDU FOR LEED CERTIFICATION

Our contribution to the efficiency and sustainability

CHART OF ISOCINDU & ISOPAN CONTRIBUTION TO LEED V4

IP Area

Prerequisite	IP P	Integrative process planning and design - Healthcare	Isocindu Team
Credit	IP C	Integrative process	Isocindu Team

SS Area

Credit	SS C4	Rainwater management	PVC Flat Roof range
Credit	SSC5	Heat island reduction	PVC Flat Roof range

EA Area

Prerequisite	EAP 1	Fundamental commissioning and verification	All ranges
Credit	EAC1	Enhanced commissioning and verification	All ranges
Prerequisite	EAP 2	Minimum energy performance	All ranges *
Credit	EAC 2	Optimize energy performance	All ranges *

MR Area

Prerequisite	MRP 2	Construction and demolition waste management planning	All ranges
Credit	MRC 5	Construction and demolition waste management	All ranges
Credit	MRC 1	Building life cycle impact reduction - option 4. LCA buildings	LCA data ref. EPD
Credit	MRC 2	Building product disclosure and optimization Environmental Product Declarations - option 1: EPD	EPD Isocop, Isobox, Isofire **
Credit	MRC 3	Building product disclosure and optimization Sourcing of raw materials - option 2: recycled content	According to range specification
Credit	MRC 4	Building product disclosure and optimization Material ingredients - option 2 REACH optimization	According to range specification

EQ Area

Credit	EQC 3	Construction indoor air quality management plan	All ranges
Credit	EQC 5	Thermal comfort	All ranges *
Credit	EQC 9	Acoustic performance	Isofire Roof Fono, Isofire Wall Fono

* Excluding corrugated sheets

** EPDs: Industry Wide – With Third party certification - Explicitly recognised as participant

- EPD-EPQ - 20130169 Double skin steel facades sandwich panels with core made of mineral wool
- EPD-EPQ - 20130170 Double skin steel facades sandwich panels with core made of polyurethane

Ref. Isocop, Isobox, Isofire Roof & Wall



MAPPED ISOCINDU / ISOPAN PRODUCTS

ROOFS Isocop Isosmart Isodomus Isotap Isodeck PVSteel Isodeck Isofire Roof - Mineral Fibre Isofire Roof Fono - Mineral Fibre Isodeck PVSteel Fibre	WALLS Standard exposed application - Isobox type Walls with concealed application – Plissé, Evo type Isofrigo MF joint Isofrigo injected joint Isofire Wall exposed application Isofire Wall concealed application - Plissé, Evo type Isofire Wall Fono	CORRUGATED SHEETS type LG 40 SYSTEMS ARK WALL Isocappotto
--	---	---

FIRE AND ACOUSTIC CERTIFICATES

Fire Reaction

Certification	Core	Panel	Panel nominal thickness (mm)																
			30	35	40	50	60	72	80	92	100	102	122	120	140	150	170	200	240
Roof Panel																			
A2 s1 d0	MW	Isofire Roof				●	●		●		●		●		●	●	●	●	
A2 s1 d0	MW	Isofire Roof Fono				●	●		●		●		●		●	●	●	●	
B s1 d0 ¹	MW	Isodeck PVSteel				●	●		●		●		●		●	●	●	●	
B s1 d0 ¹	PIR	Isocop	●		●	●	●		●		●		●		●				
B s1 d0 ¹	PIR	Isotap	●		●	●	●		●		●		●		●				
B s2 d0	PIR	Isocop	●		●	●	●		●		●		●		●				
B s2 d0	PIR	Isodeck PVSteel	●		●	●	●		●		●		●		●				
B s2 d0	PIR	Isodomus Classic	●		●	●	●		●		●		●		●				
B s2 d0	PIR	Isotap	●		●	●	●		●		●		●		●				
B s3 d0	PUR	Isocop	●		●	●	●		●		●		●		●				
C s3 d0	PUR	Isocop							●		●		●		●		●		
C s3 d0	PUR	Isotap	●		●	●	●		●		●		●		●				
C s3 d0	PUR	Isodeck PVSteel	●		●	●	●		●		●		●		●				
C s3 d0	PUR	Isodomus Classic	●		●	●	●		●		●		●		●				

			Panel nominal thickness (mm)																	
Certification	Core	Panel	Panel nominal thickness (mm)																	
			30	35	40	50	60	72	80	92	100	102	122	120	140	150	170	200	240	
Wall Panel																				
A2 s1 d0	MW	Isofire Wall				●	●		●		●		●		●		●	●	●	●
A2 s1 d0	MW	Isofire Wall Fono				●	●		●		●		●		●		●	●	●	●
A2 s1 d0	MW	Isofire Wall Striated				●	●		●		●		●		●		●	●		
B s1 d0 ¹	PIR	Isobox	●	●	●	●	●		●		●		●		●					
B s1 d0 ¹	PIR	Isoparete			●	●	●		●		●		●		●	●				
B s1 d0 ¹	PIR	Isoclass						●		●		●	●		●					
B s2 d0	PIR	Isobox / Isopiano	●	●	●	●	●		●		●		●		●					
B s2 d0	PIR	Isoparete			●	●	●		●		●		●		●	●				
B s2 d0	PIR	Isoclass						●		●		●	●		●					
B s2 d0	PUR	Isoparete			●	●	●		●		●		●		●	●				
B s2 d0	PUR	Isoclass						●		●		●	●		●					
B s3 d0	PUR	Isobox / Isopiano	●	●	●	●	●		●		●		●		●					

Acoustic Insulation

Certification	Core	Panel	Panel nominal thickness (mm)																
			30	35	40	50	60	72	80	92	100	102	122	120	140	150	170	200	240
Roof Panel																			
RW = 36 dB	MW	Isofire Roof Fono																	●
RW = 35 dB	MW	Isofire Roof Fono							●										
RW = 34 dB	MW	Isofire Roof Fono									●			●		●	●	●	●
RW = 31 dB	MW	Isofire Roof Fono				●	●												
RW = 34 dB	MW	Isofire Roof																	●
RW = 30 dB	MW	Isofire Roof				●													
RW = 29 dB	PIR	Isocop									●			●		●			
RW = 24 dB	PUR	Isodomus Classic			●	●	●		●					●		●			
Wall Panel																			
RW = 35 dB	MW	Isofire Wall Fono							●		●			●		●	●	●	●
RW = 34 dB	MW	Isofire Wall Fono				●	●												
RW = 34 dB	MW	Isofire Wall														●	●	●	●
RW = 30 dB	MW	Isofire Wall							●		●			●		●	●	●	●
RW = 29 dB	PIR	Isoparete Plissé									●			●	●				

FIRE AND ACOUSTIC CERTIFICATES

Fire Resistance

Certification	Core	Panel	Panel nominal thickness (mm)																	
			30	35	40	50	60	72	80	92	100	102	122	120	140	150	170	200	240	
Roof Panel																				
REI 240	MW	Isofire Roof																		●
REI 180	MW	Isofire Roof ¹								●			●		●	●				
REI 120	MW	Isofire Roof								●			●		●	●				
REI 120	MW	Isofire Roof Fono										●		●	●	●				
REI 120	MW	Isodeck PVSteel										●		●	●	●				
REI 60	MW	Isofire Roof						●												
REI 60	MW	Isofire Roof Fono						●		●			●		●	●	●			
REI 30	MW	Isofire Roof				●	●													
REI 30	PIR	Isocop ¹								●			●		●					
REI 15	PIR	Isodeck PV Steel ¹								●			●		●					
REI 15	PIR	Isocop ¹					●		●											
REI 15	PUR	Isocop ¹						●		●			●		●					
Wall Panel																				
EI 180	MW	Isofire Wall / Fono														●	●	●	●	
EI 120 ¹	MW	Isofire Wall / Fono								●			●		●	●	●	●	●	
EI 90	MW	Isofire Wall / Fono										●		●	●	●	●	●	●	
EI 60	MW	Isofire Wall						●		●										
EI 30 ¹	MW	Isofire Wall / Fono				●	●													
EI 30 ¹	MW	Isofire Wall Striated								●			●		●	●				
EI 30 ¹	PIR	Isobox / Isopiano								●			●							
EI 20 ¹	PIR	Isobox / Isopiano					●		●	●			●							
EI 20 ¹	PIR	Isoparete								●			●	●						
EI 15	MW	Isofire Wall / Fono				●	●						●		●					
EI 15	PIR	Isobox / Isopiano					●		●	●			●							
EW 240 ¹	MW	Isofire Wall													●	●	●			
EW 60 ¹	PUR	Isobox / Isopiano						●		●			●							

Acoustic Absorption

Certification	Core	Panel	Panel nominal thickness (mm)																	
			30	35	40	50	60	72	80	92	100	102	122	120	140	150	170	200	240	
Roof Panel																				
αW = 1	MW	Isofire Roof Fono				●	●			●			●		●	●	●		●	
αW = 1	MW	Isodeck PVSteel Fono				●	●			●			●		●	●	●		●	
Wall Panel																				
αW = 1	MW	Isofire Wall Fono				●	●			●			●		●	●	●		●	

● Certificate with extension ● Performance available with technical note

The performances stated in the following tables, associated with the different types of insulation, may vary according to the production plant, in accordance with the local and national regulations in force. For further details, please contact Isocindu's technical department. If not expressly requested, performance will not be provided.

Reaction to Fire Classes in accordance with EN 13501-1 y EN 14509/2013.

Fire resistance in accordance with EN 13501-2 y EN 14509/2013.

Achievable performance by following the assembly instructions correctly.

(¹) Special Formula - Contact IsoCindu

FINISHES AND COLORS

Finish

Steel finish



Piano Finish



Embossed



Stainless Steel

Standard Polyester

These represent IsoCindu standard



RAL 9010
Pure White



RAL 9002
White Grey

Siliconized Modify Polyester

Consult availability and delivery time



SIMIL RAL 9010
Pure White



SIMIL RAL 9002
White Grey



SIMIL RAL 9001
Cream

External and internal faces

Is important to consider that the two faces of the panel will be in contact with two significantly different environments.

The external face will be in contact with the pollutants in the atmosphere, sun and solar spectrum UV rays. In addition to, raising the temperature of the external metal face, will cause a physical-chemical reaction on the organic coating. Internal faces will have a temperature significantly lower due to insulation of the panel. The internal environment, the pollutants of production lines and chemical agents used in those processes, all need to be considered for the internal panel face selection.

A pre-lacquered steel product is composed of zinc base coat with subsequent primer and finish coats.



U.V Rays



Rust



Condensation



Chemical
Attack



Erosion

Face Options:

- 1) Hot zinc steels, zinc-aluminized steel, pre-lacquered steel.
- 2) Natural aluminum or pre-lacquered, copper and stainless steel.

IMPORTANT: For stock availability, thickness, supports, non-standard colors and guarantees, contact IsoCindu. Colors may vary depending on the batch of numeric codes that correspond to the most similar RAL code. *Custom colors will be an up charged

Solid PVDF Colors – Kynar 500® / Hylar 5000

Coatings are durable polyvinylidene systems containing 70% Kynar or Hylar resins, ceramic and other inorganic pigments. This system provides a powerful chemical bond, resistance to ultraviolet radiation with exceptional color retention, chalking resistance, and chemical degradation, 20 years warranty.

Category 1



RAL 9010
Pure White

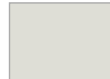

RAL 9002
White Grey

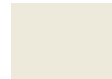

SIMIL RAL 9001
Cream

Category 2



SIMIL RAL 9006
Silver Grey



SIMIL RAL 1013
Pearl White



SIMIL RAL 1015
Light Ivory



SIMIL RAL7010
Tarpaulin Gray

Category 3



SIMIL RAL 5010
Genecian Blue



SIMIL RAL 6028
Pine Green



SIMIL RAL 7016
Anthracite Grey



SIMIL RAL 8004
Cooper Brown

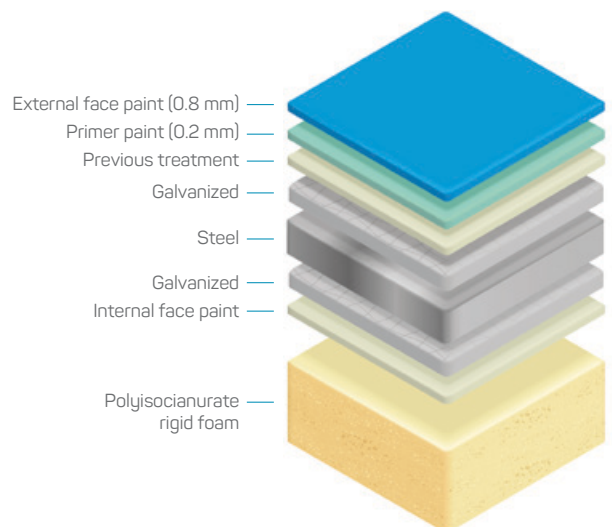



Roof Panel

Roof Panel

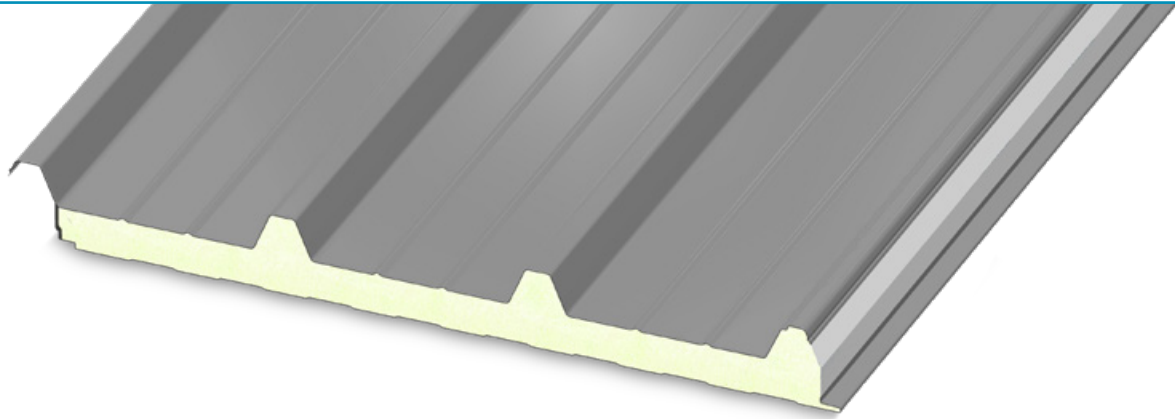

Features

A double-steel sheet roof panel assembly insulated with polyisocyanurate rigid foam. This design caters to “low sloped” pitched roofs. Sheets have (4) trapezoidal rows on each panel to enhance static and dynamic forces. Panels have an exposed fastening system that includes saddle clips at each anchoring point. Systems applicable in design to incorporate within a multitude of roofing sub-structure assemblies.

Options

The panel is especially suited for use in industrial, warehouses, zootechnical, and residential construction. Versatility, load resistance and easy installation make Isocop a reliable solution for any kind of intervention, from new construction to roof refurbishing.

Benefits

- Rust resistance
- High mechanical strength
- Hygienic
- Easy wash material
- Mold and humidity resistance
- Gasket barrier to prevent vapor leaks



Specifications

Standard Length:	Typical panel length is 8' up to a maximum of 54' (Subject to transportation limitations)
Width	39 3/4"
Joint:	Interconnecting male/female
Thickness:	1 1/2" 2" 2 1/2" 3" 4" 5" 6" 8"
Exterior Face	Prepainted steel
Interior Face:	Shadowline profile
Foam Density:	2.49 LB/FT ³
Exterior Finish:	Polyester coating
Interior Finish:	Polyester coating
Joint Type:	Exposed

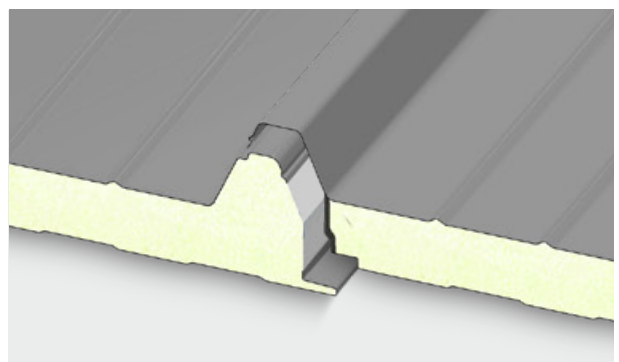

For trims and accessories, ask your sales rep or contact Isocindu for more information and availability.

Overload Wheelbase Load Distribution / Max Spans ft/in

PSF	Panel Nominal Thickness (in/mm)							
	1½"	2"	2½"	3"	4"	5"	6"	8"
Steel Sheets 24/26 (Ga) - Bearing 4½"								
16.38	10' 5½"	12' 1½"	13' 5¾"	16' 4¼"	18' 6¾"	19' 6¼"	20' 2½"	20' 10"
20.48	9' 4½"	10' 9½"	12' 1½"	14' 7½"	16' 2½"	17' 4½"	18' ½"	18' 8¾"
30.72	7' 6½"	8' 8¾"	9' 10"	11' 9¾"	13' 5¾"	14' 7½"	15' 5"	16' 2½"
40.96	6' ¾"	7' ¾"	8' 4¾"	9' 8¾"	11' 3¾"	12' 7½"	13' 7¾"	14' 7½"
51.20	4' 11"	5' 10¾"	6' 8¾"	8' 4¾"	9' 10"	10' 11¾"	11' 9¾"	12' 7½"
Steel Sheets 24/26 (Ga) - Bearing 4½"								
16.38	11' 3¾"	12' 11½"	13' 7¾"	17' 5"	19' ¼"	20' 2½"	20' 10"	21' 5¾"
20.48	10' 2"	11' 9¾"	12' 7½"	15' 3"	17' 2½"	18' 4¾"	19' 4¼"	20' ½"
30.72	8' 5¾"	9' 10"	10' 5¾"	12' 11½"	14' 7½"	15' 8¾"	16' 6¾"	17' 2½"
40.96	6' 8¾"	8' ¾"	8' 8¼"	10' 7¾"	12' 5½"	13' 7¾"	14' 3¼"	14' 11¾"
51.20	5' 4¾"	6' 6¾"	7' 6½"	9' 4¾"	10' 9¾"	11' 11¾"	12' 9½"	13' 7¾"

Overload Wheelbase Load Distribution / Max Spans ft/in

PSF	Panel Nominal Thickness (in)							
	1½"	2"	2½"	3"	4"	5"	6"	8"
Steel Sheets 24/26 (Ga) - Bearing 4½"								
16.38	12' 3¾"	14' 3¼"	15' 8¾"	18' 8¾"	21' 3¾"	22' 7¾"	24' 1¼"	24' 11½"
20.48	10' 11¾"	12' 7½"	14' 5½"	17' 2¾"	19' ¼"	20' 4"	21' 3¾"	22' 1¾"
30.72	8' 10¼"	10' 4"	11' 9¾"	14' 1¼"	16' 7½"	17' 8½"	18' 8¾"	19' 6¼"
40.96	7' 4½"	8' 8¾"	10' 2"	11' 5¼"	13' 9¼"	15' 5"	16' 8¾"	17' 8½"
51.20	6' 2¾"	7' 6½"	8' 6¼"	10' 2"	12' 1½"	13' 7¾"	14' 9½"	15' 8¾"
Steel Sheets 24/26 (Ga) - Bearing 4½"								
16.38	13' 1¾"	15' 1"	15' 10¾"	19' 4¼"	22' 1¾"	23' 9¾"	25' 1½"	26' 2¾"
20.48	11' 9¾"	13' 7¾"	14' 11½"	17' 10½"	20' ½"	21' 3¾"	22' 3¾"	23' 3¾"
30.72	9' 10"	11' 7¾"	12' 5½"	15' 3"	17' 2½"	18' 8¾"	19' 8½"	20' 8"
40.96	8' ¾"	9' 8¾"	10' 5¾"	12' 5½"	14' 11¾"	16' 7½"	17' 6¾"	18' 8¾"
51.20	6' 8¾"	8' 2¾"	9' 4½"	11' 1¾"	13' 1¾"	14' 7½"	15' 8¾"	16' 10¼"

Joint Section

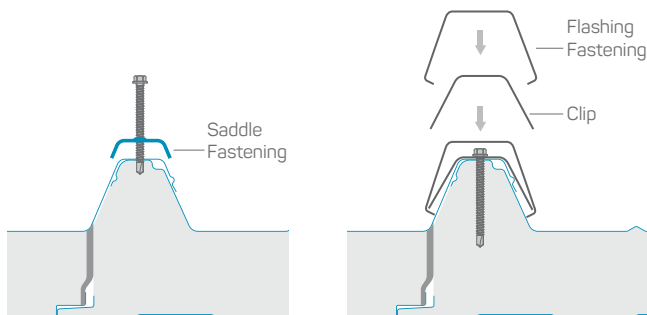

Panel Weight

Steel thickness	Panel Nominal Thickness (in)							
	1½"	2"	2½"	3"	4"	5"	6"	8"
26/26 PSF	2.05	2.14	2.24	2.33	2.52	2.70	2.89	3.27
24/26 PSF	2.42	2.51	2.61	2.70	2.85	3.04	3.26	3.64
24/24 PSF	2.75	2.85	2.94	3.04	3.22	3.41	3.60	3.97
22/26 PSF	2.70	2.70	2.88	2.98	3.16	3.35	3.54	3.91

Thermal Insulation

R	Panel Nominal Thickness (in)							
	1½"	2"	2½"	3"	4"	5"	6"	8"
75° F Mean Temp (23.9 °C) According to ASTM C518								
m²K/W	1.86	2.48	3.10	3.72	4.96	6.20	7.44	9.92
H ft² F/Btu	10.56	14.08	17.61	21.13	28.17	35.21	42.25	56.34
35° F Mean Temp (1.67 °C) According to ASTM C518								
m²K/W	2.08	2.77	3.46	4.16	5.54	6.93	8.32	11.09
H ft² F/Btu	11.81	15.75	19.69	23.62	31.50	39.37	47.24	62.99

Dimensional Tolerance

Length	L ≤ 9' 10" ± ¼" L > 9' 10" ± ¾"	Perpendicularity Deviation	¼"
Working Length	± 2 mm	Misalignment of the internal metal surfaces	± ⅛"
Thickness	D ≤ 4" ± ¼" D > 4" ± 2%	Bottom Sheet Coupling	F = 1 + ⅛"

L = working length, D = panel thickness, F = sheet coupling

These Span & Load Charts were converted from Metric to Imperial Units. The performance criteria was developed from years of products testing used in ISOPAN Europe / ISOCINDU Central & South America. Actual Load Calculation Requirements are Project specific and must be determined by the Design Team and/or the Structural Engineer of Record. Manni Green Tech will provide assistance, as may be required, to determine the best system for the specific Project Design Requirements. These Charts are for base reference use only.

Overlapping

D = 4" - 6" - 8" - 10"

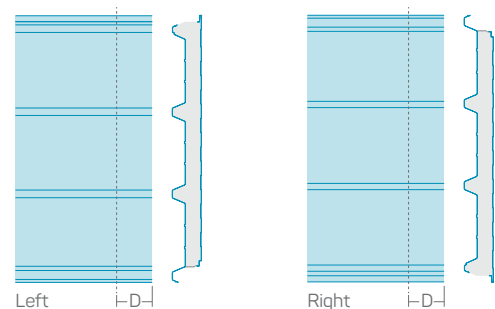

PVSteel / TPO

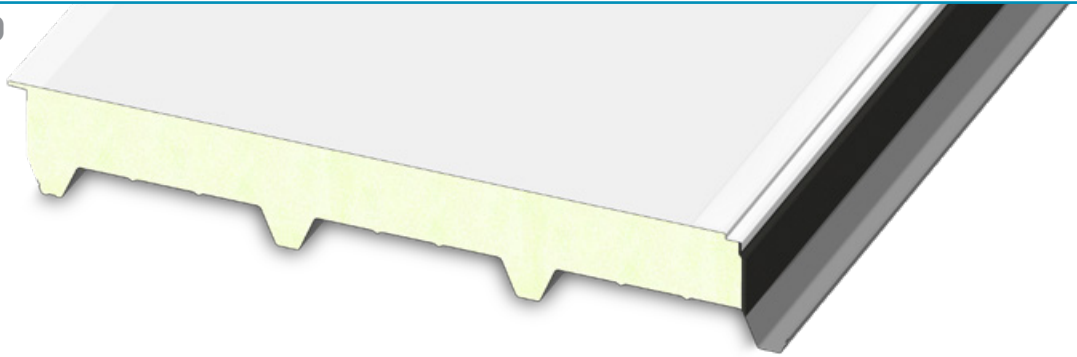

Features

This system is our isocop panel inverted to allow application of a PVC or TPO roofing system. The addition of being able to apply a single PLY membrane system to our polyiso panel is ideal for flat to very low roof slopes. Further, providing a waterproofed and aesthetically pleasing system in any location. The system is ideal for commercial and industrial applications.

Options

The panel is characterized by the presence of a special pvc-coated inner support that gives the panel excellent resistance to the action of aggressive agents present in the interior agro-zootechnical environments. With ribbed profile, designed for flat roofs.

Benefits

- High resistance to atmospheric agents and U.V. rays.
- High mechanical strength
- High puncture resistance
- High water intrusion resistance
- High resistance to moderate chemical degradation
- Gasket barrier to prevent vapor leaks



Specifications

Standard Length:	Typical panel length is 8' up to a maximum of 26' (Subject to transportation limitations)
Width	39 3/8"
Joint:	Interconnecting male/female
Thickness:	2" 2 1/2" 3" 4" 5" 6" 8"
Exterior Face	Prepainted steel
Interior Face:	PVC Film
Foam Density:	2.49 LB/FT ³
Exterior Finish:	Polyester coating
Interior Finish:	Polyester coating
Joint Type:	Hidden

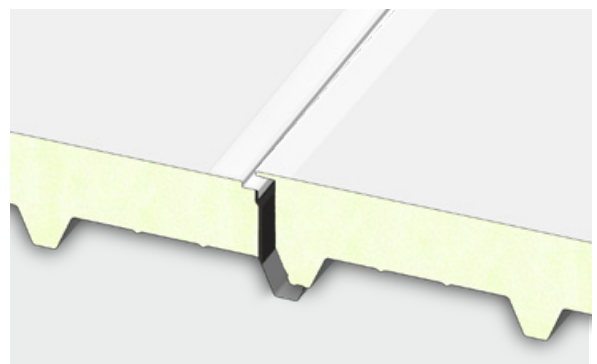

For trims and accessories, ask your sales rep or contact Isocindu for more information and availability.

PVSteel / TPO

Overload Wheelbase Load Distribution / Max Spans ft/in

PSF	Panel Nominal Thickness (in/mm)						
	2"	2½"	3"	4"	5"	6"	8"
	50.8	63.5	76.2	101.6	127	152.4	203.2
Steel Sheets 26/20 (Ga) - Bearing 4½"							
12.29	13' 3¾"	15' 10⅞"	16' 10¾"	19' 8⅞"	21' 7¾"	23' 3½"	24' 7¼"
16.38	11' 9⅞"	13' 5¾"	15' 5"	17' 8½"	19' 2¼"	20' 10"	21' 3⅞"
20.48	10' 7⅞"	12' 7½"	14' 5⅞"	16' 2⅞"	17' 4⅞"	18' 4⅞"	20' ⅞"
24.57	9' 10"	11' 7¾"	13' 1⅞"	14' 9⅞"	16' ⅞"	17' 2⅞"	18' 4⅞"
30.72	8' 6¼"	10' 5⅞"	11' 3¾"	13' 1⅞"	13' 11¼"	15' 3"	17' 4⅞"
40.96	7' 2½"	8' 10¼"	10'	11' 5¾"	12' 5½"	13' 4⅞"	15' 1"
51.20	6' 4¾"	7' 4½"	8' ¾"	10'	11' 9⅞"	11' 8⅞"	14' 5⅞"
61.44	5' 6⅞"	6' 2¾"	6' 10⅞"	8' ¾"	8' 9½"	9' 6⅞"	10' 5⅞"

Overload Wheelbase Load Distribution / Max Spans ft/in

PSF	Panel Nominal Thickness (in)						
	2"	2½"	3"	4"	5"	6"	8"
Steel Sheets 26/20 (Ga) - Bearing 4½"							
12.29	14' 5⅞"	17' ⅞"	18' ½"	20' 10"	22' 9½"	24' 5¼"	25' 9"
16.38	12' 11½"	14' 7⅞"	16' 6¾"	18' 10⅞"	20' 4"	21' 11¼"	22' 5⅞"
20.48	11' 9⅞"	13' 9¼"	15' 1½"	17' 4⅞"	18' 6⅞"	19' 6¼"	21' 1⅞"
24.57	10' 11⅞"	12' 9½"	14' 3¼"	15' 10⅞"	17' 2⅞"	18' 4⅞"	19' 6¼"
30.72	9' 8⅞"	11' 7¾"	12' 5½"	14' 3¼"	15' 1"	16' 4¼"	18' 6⅞"
40.96	8' 8⅞"	10'	11' 1¾"	12' 7½"	13' 7⅞"	14' 6⅞"	16' 2⅞"
51.20	7' 6½"	8' 6¼"	9' 2⅞"	11' 1¾"	12' 11½"	12' 10⅞"	15' 7"
61.44	6' 8⅞"	7' 4½"	8' ¾"	9' 2⅞"	9' 11¼"	10' 7⅞"	11' 7¼"

Joint Section

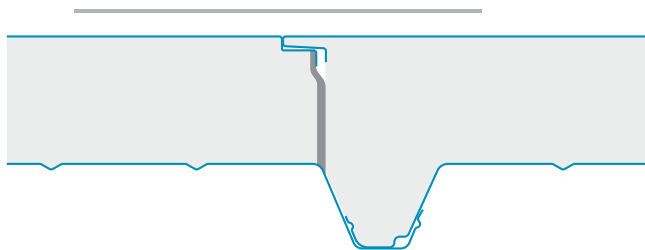

Panel Weight

Steel thickness		Panel Nominal Thickness (in)						
		2"	2½"	3"	4"	5"	6"	8"
26/26	PSF	2.14	2.24	2.33	2.52	2.70	2.89	3.27
24/26	PSF	2.51	2.61	2.70	2.85	3.04	3.26	3.64
24/24	PSF	2.85	2.94	3.04	3.22	3.41	3.60	3.97
22/26	PSF	2.70	2.88	2.98	3.16	3.35	3.54	3.91

Thermal Insulation

R	Panel Nominal Thickness (in)						
	2"	2½"	3"	4"	5"	6"	8"
75° F Mean Temp (23.9 °C) According to ASTM C518							
m²K/W	2.48	3.10	3.72	4.96	6.20	7.44	9.92
H ft² F/Btu	14.08	17.61	21.13	28.17	35.21	42.25	56.34
35° F Mean Temp (1.67 °C) According to ASTM C518							
m²K/W	2.77	3.46	4.16	5.54	6.93	8.32	11.09
H ft² F/Btu	15.75	19.69	23.62	31.50	39.37	47.24	62.99

Dimensional Tolerance

Length	L ≤ 9' 10" ± ⅛" L > 9' 10" ± ⅜"	Perpendicularity Deviation	¼"
Working Length	± 2 mm	Misalignment of the internal metal surfaces	± ⅛"
Thickness	D ≤ 4" ± ⅛" D > 4" ± 2%	Bottom Sheet Coupling	F = 1 + ⅛"

L = working length, D = panel thickness, F = sheet coupling

These Span & Load Charts were converted from Metric to Imperial Units. The performance criteria was developed from years of products testing used in ISOPAN Europe / ISOCINDU Central & South America. Actual Load Calculation Requirements are Project specific and must be determined by the Design Team and/or the Structural Engineer of Record. Manni Green Tech will provide assistance, as may be required, to determine the best system for the specific Project Design Requirements. These Charts are for base reference use only.

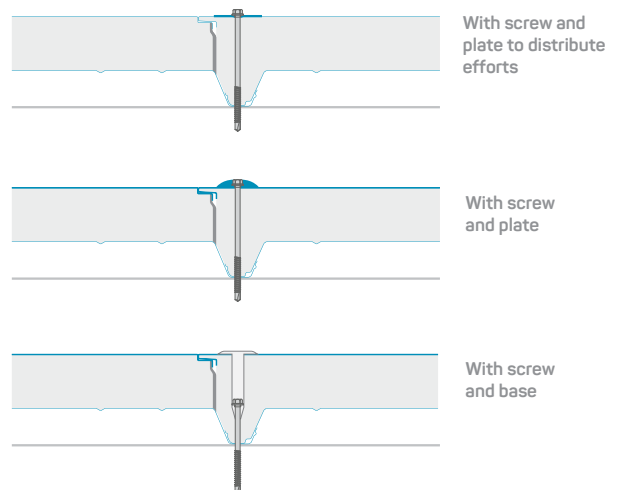

Isodeck PVSteel

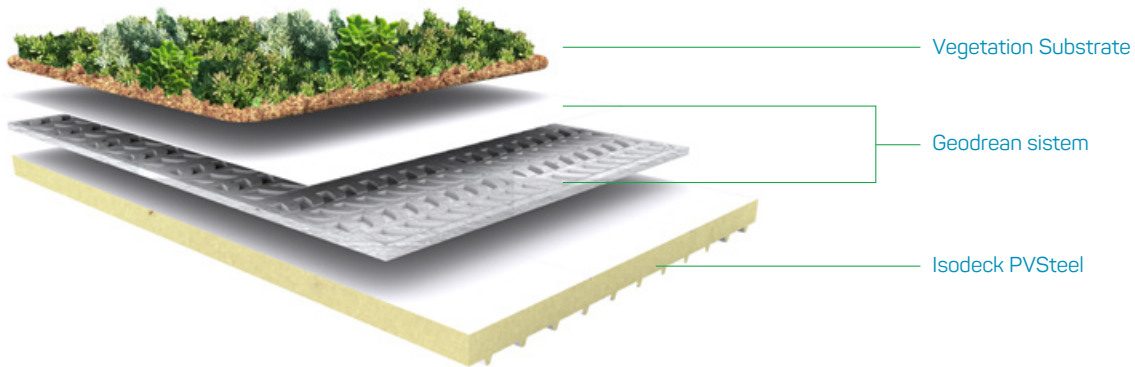

Isocindu Green Roof is the sustainable solution for flat-roofed buildings; it gives value to residential, commercial and industrial buildings.

Features

GreenRoof integration consists in the green roof system being integrated into a flat roof made with an Isodeck PVSteel or Isodeck TPO sandwich panel, ideal for extensive or semi-intensive roofs with vegetation thickness of 5". Thermal insulation is guaranteed by the insulating core in polyurethane foam and an outer sheet covered with a special anti-root waterproof film with high durability.

Benefits

- High resistance to atmospheric agents and U.V. rays
- High mechanical strength
- High puncture resistance
- High water intrusion resistance
- High resistance to moderate chemical degradation

Specifications

Isocindu Panel:	Isodeck PVSteel
Insulating core	Polyurethane or mineral wool
Exterior Face	Prepainted steel plane
Maintenance:	Extensive, punctual
Maintenance:	Semi Intensive, sporadic

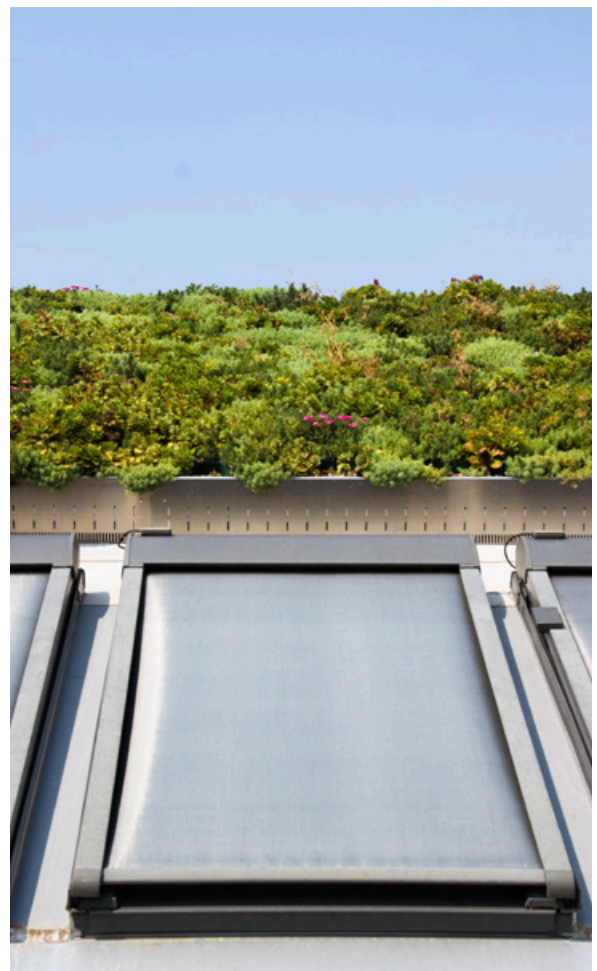



Wall Panel

ISOPARETE

Wall Panel

Box / Striated / Flat

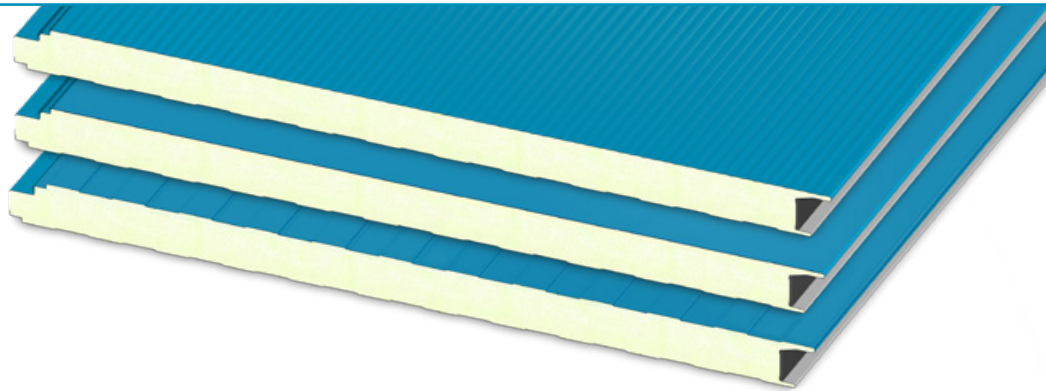

Features

A double-steel sheet wall panel, insulated with polyisocyanurate rigid foam. The tongue-and-groove joint completed by concealed fasteners and saddle clip. External faces are available in striated, box, and flat profiles. The internal face is standard with the box profile (contact us for other options)

Options

Isoparete is a sandwich panel characterized by a hidden fixing joint system, used for industrial and commercial building walls, and perfect solution for cold storage industries. It can be used in combination with wall sandwich panels Isoclass and Isoparete.

Benefits

- Suitable for controlled temperatures
- Gasket barrier to prevent vapor leaks
- High mechanical strength
- High puncture resistance
- High thermal resistance
- Up to 8" thick
- Possibility of combination with compatible panels



Specifications

Standard Length:	Typical panel length is 8' up to a maximum of 54' (Subject to transportation limitations)
Width	39 3/4"
Joint:	Interconnecting male/female
Thickness:	1 1/2" 2" 2 1/2" 3" 4" 5" 6" 8"
Exterior Face	Prepainted steel
Interior Face:	Shadowline profile
Foam Density:	2.49 LB/FT ³
Exterior Finish:	Polyester coating
Interior Finish:	Polyester coating
Joint Type:	Hidden

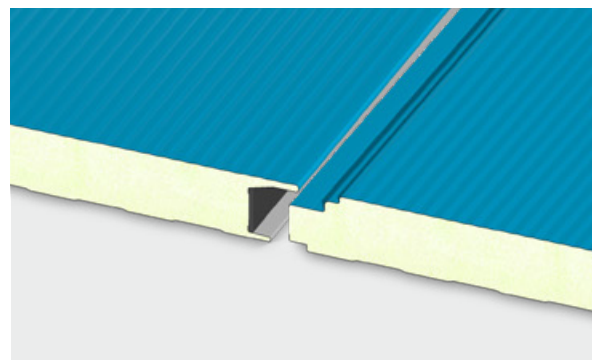

For trims and accessories, ask your sales rep or contact Isocindu for more information and availability.

Box / Striated / Flat

Overload Wheelbase Load Distribution / Max Spans ft/in

PSF	Panel Nominal Thickness (in/mm)							
	1½"	2"	2½"	3"	4"	5"	6"	8"
	41.27	50.8	63.5	76.2	101.6	127	152.4	203.2
Steel Sheets 24/26 (Ga) - Bearing 4½"								
10.24	10' 5½"	12' 5½"	14' 5½"	17' 5½"	19' 8½"	22' 1½"	25' 7½"	29' 1½"
12.29	9' 10"	11' 5¾"	13' 5"	15' 6½"	18' 4¾"	20' 10"	22' 7½"	26' 1½"
16.38	8' 6¼"	10' 1½"	11' 5¾"	13' 7¾"	16' ¾"	18' 3¾"	20' 8"	24' 2"
20.48	7' 6½"	9' ¼"	10' 5½"	12' 3¾"	14' 9½"	16' 10¾"	18' 8¾"	22' 2¾"
24.57	6' 10½"	8' 2¾"	9' 6½"	11' 1¾"	13' 7¾"	15' 7"	17' 2½"	20' 8½"
28.67	6' 2¾"	7' 6½"	8' 8¼"	10' 1½"	12' 7½"	14' 7½"	15' 8½"	19' 2½"
32.77	5' 8¾"	6' 10½"	8' ¾"	9' 6½"	11' 11½"	13' 7¾"	15' 1"	18' 7"
36.86	5' 4¾"	6' 4¾"	7' 6½"	9' ¼"	11' 3¾"	12' 11½"	13' 11¼"	17' 5¼"
40.96	5' ¾"	6' ¾"	7' ¾"	8' 4¾"	10' 7¾"	12' 3¾"	13' 5¾"	16' 11¾"

Overload Wheelbase Load Distribution / Max Spans ft/in

PSF	Panel Nominal Thickness (in)							
	1½"	2"	2½"	3"	4"	5"	6"	8"
Steel Sheets 24/26 (Ga) - Bearing 4½"								
10.24	12' 5½"	14' 9½"	17' ¾"	20' 2½"	22' 11½"	24' 7½"	27' 2½"	28' 8½"
12.29	11' 1¾"	13' 5½"	15' 5"	18' 4¾"	20' 8"	21' 11¼"	26' 4¾"	27' 10¾"
16.38	9' 6½"	11' 5¾"	13' 5¾"	15' 7"	17' 2½"	18' 8¾"	24' 3¼"	25' 9¼"
20.48	8' 6¼"	10' 2"	11' 9½"	13' 9¼"	15' 5"	16' ¾"	20' 11½"	22' 5½"
24.57	7' 6½"	9' 2½"	10' 5½"	12' 1½"	13' 7¾"	14' 7½"	18' 2½"	19' 8½"
28.67	6' 6½"	8' 2¾"	9' 8½"	11' 1¾"	12' 5½"	13' 5½"	16' 6¾"	18' 3¾"
32.77	6' ¾"	7' 2½"	8' 8¼"	10' 2"	11' 7¾"	12' 3¾"	15' 1"	16' 7"
36.86	5' 2¾"	6' 6½"	7' 10½"	9' 4½"	11' 1¾"	11' 7¾"	13' 9¼"	15' 3¼"
40.96	4' 9"	5' 10¾"	7' 5½"	8' 8¼"	10' 4"	10' 11½"	13' 1¾"	14' 7¾"

External face profile

Box

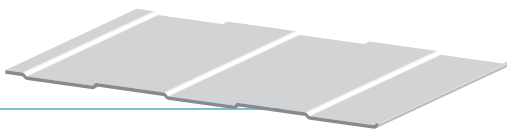

Striated

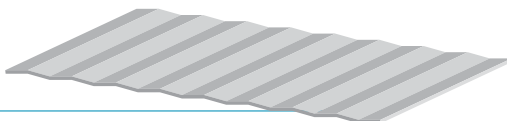

Flat

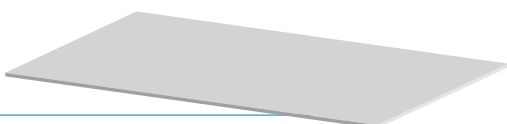

Panel Weight

Steel thickness		Panel Nominal Thickness (in)							
		1½"	2"	2½"	3"	4"	5"	6"	8"
26/26	PSF	2.07	2.14	2.24	2.33	2.52	2.70	2.89	3.27
24/26	PSF	2.44	2.51	2.61	2.70	2.85	3.04	3.26	3.64
24/24	PSF	2.78	2.85	2.94	3.04	3.22	3.41	3.60	3.97
22/26	PSF	2.72	2.70	2.88	2.98	3.16	3.35	3.54	3.91

Thermal Insulation

R	Panel Nominal Thickness (in)							
	1½"	2"	2½"	3"	4"	5"	6"	8"
75° F Mean Temp (23.9 °C) According to ASTM C518								
m²K/W	2.01	2.48	3.10	3.72	4.96	6.20	7.44	9.92
H ft² F/Btu	11.44	14.08	17.61	21.13	28.17	35.21	42.25	56.34
35° F Mean Temp (1.67 °C) According to ASTM C518								
m²K/W	2.25	2.77	3.46	4.16	5.54	6.93	8.32	11.09
H ft² F/Btu	12.81	15.75	19.69	23.62	31.50	39.37	47.24	62.99

Dimensional Tolerance

Length	L ≤ 9' 10" ± ¼"	Perpendicularity Deviation	¼"
	L > 9' 10" ± ¾"		
Working Length	± 2 mm	Misalignment of the internal metal surfaces	± ⅛"
Thickness	D ≤ 4" ± ¼"	Bottom Sheet Coupling	F = 1 + ⅛"
	D > 4" ± 2%		

L = working length, D = panel thickness, F = sheet coupling

These Span & Load Charts were converted from Metric to Imperial Units. The performance criteria was developed from years of products testing used in ISOPAN Europe / ISOCINDU Central & South America. Actual Load Calculation Requirements are Project specific and must be determined by the Design Team and/or the Structural Engineer of Record. Manni Green Tech will provide assistance, as may be required, to determine the best system for the specific Project Design Requirements. These Charts are for base reference use only.

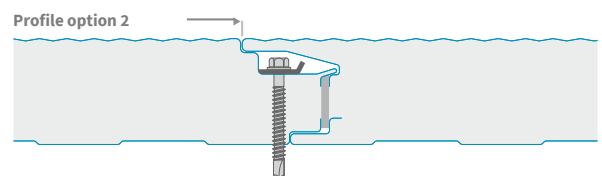
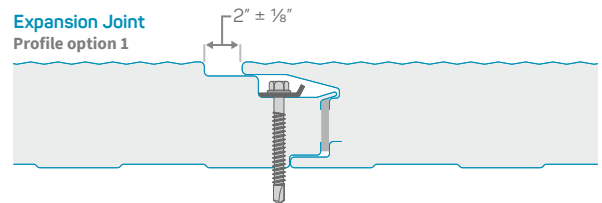

ISOBOX / SUPER ISOBOX

Wall Panel

Box / Striated / Flat

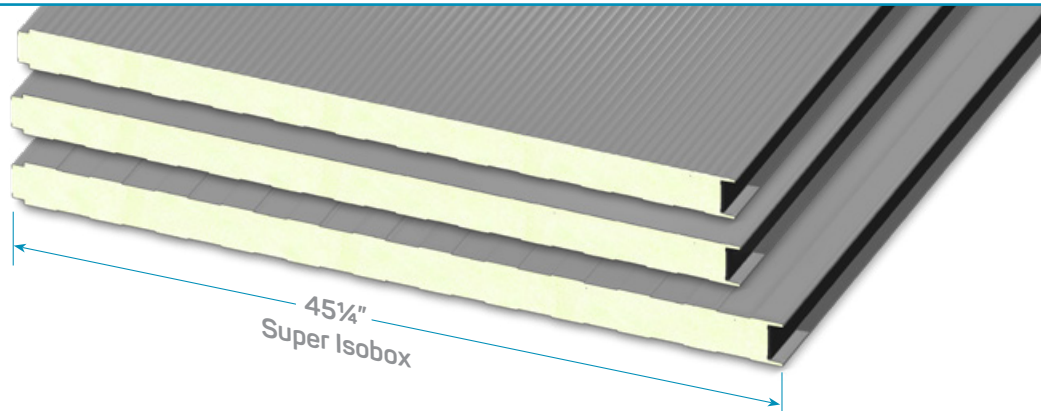

Features

A double-steel sheet wall panel, insulated with polyisocyanurate rigid foam. The tongue-and-groove joint is completed by exposed fasteners and saddle clip. External face available in striated, box and flat profiles. The internal face is standard with the box profile (contact us for other options).

Options

IsoBox is a sandwich panel for coating used in walls of industrial buildings, and internal partitions, suitable for cooling chambers. Available in 45 1/4" width, perfect size for cold storage.

Benefits

- Suitable for controlled temperatures
- Up to 8" thick
- Available in 45 1/4" width
- Gasket barrier to prevent vapor leaks
- High mechanical strength
- High puncture resistance
- High thermal resistance

Specifications

Standard Length: Typical panel length is 8' up to a maximum of 54' (Subject to transportation limitations)

Width: 39 3/8" / 45 1/4"

Joint: Interconnecting male/female

Thickness: 1 1/8" 2" 2 1/2" 3" 4" 5" 6" 8"

Exterior Face: Prepainted steel

Interior Face: Shadowline profile

Foam Density: 2.49 LB/FT³

Exterior Finish: Polyester coating

Interior Finish: Polyester coating

Joint Type: Exposed

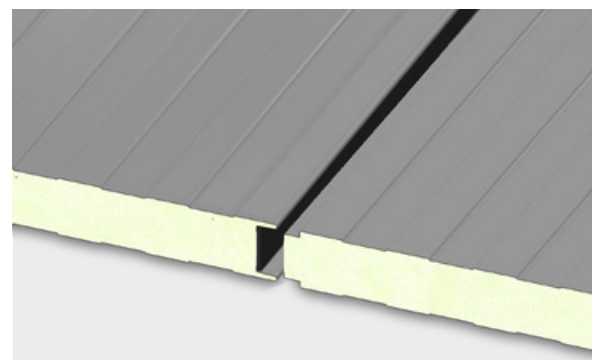

For trims and accessories, ask your sales rep or contact Isocindu for more information and availability.

Box / Striated / Flat

Overload Wheelbase Load Distribution / Max Spans ft/in

PSF	Panel Nominal Thickness (in/mm)							
	1½"	2"	2½"	3"	4"	5"	6"	8"
	41.2	50.8	63.5	76.2	101.6	127	152.4	203.2
Steel Sheets 24/26 (Ga) - Bearing 4½"								
10.24	10' 5½"	12' 5½"	14' 5½"	18' ¾"	19' 8¼"	22' 1¼"	25' 7½"	29' 1½"
12.29	9' 9¾"	11' 5¼"	13' 5¾"	16' 4¾"	18' 4¾"	20' 10"	22' 7½"	26' 1½"
16.38	8' 6¼"	10' 2"	11' 5¼"	14' 5½"	16' ¾"	18' 3¾"	20' 8"	24' 2"
20.48	7' 6½"	9' ¼"	10' 5½"	12' 11½"	14' 9¾"	16' 10¾"	18' 8¾"	22' 2½"
24.57	6' 10½"	8' 2¾"	9' 6½"	11' 9¾"	13' 7¾"	15' 7"	17' 2¾"	20' 8¾"
28.67	6' 2¾"	7' 6½"	8' 8¼"	10' 9¾"	12' 7½"	14' 7½"	15' 8¾"	19' 2¾"
32.77	5' 8¾"	6' 10¾"	8' ¾"	10' 2"	11' 11½"	13' 7¾"	15' 1"	18' 7"
36.86	5' 4¾"	6' 4¾"	7' 6½"	9' 6½"	11' 3¾"	12' 11½"	13' 11¼"	17' 5¼"
40.96	5' 1"	6' ¾"	7' ¾"	8' 10¼"	10' 7¾"	12' 3¾"	13' 5¾"	16' 11¾"

Overload Wheelbase Load Distribution / Max Spans ft/in

PSF	Panel Nominal Thickness (in)							
	1½"	2"	2½"	3"	4"	5"	6"	8"
Steel Sheets 24/26 (Ga) - Bearing 4½"								
10.24	12' 5½"	14' 9¾"	17' ¾"	20' 3¾"	22' 11½"	24' 7¾"	27' 2¾"	29' ¾"
12.29	11' 1¾"	13' 5¾"	15' 5"	19' 4¾"	20' 8"	21' 11¼"	26' 4¾"	27' ¾"
16.38	9' 6½"	11' 5¼"	13' 5¾"	16' 4¾"	17' 2¾"	18' 8¾"	24' 3¼"	26' 7½"
20.48	8' 6¼"	10' 2"	11' 9¾"	14' 5½"	15' 5"	16' 7½"	20' 11½"	22' 5¾"
24.57	7' 6½"	9' 2½"	10' 5½"	12' 9½"	13' 7¾"	14' 7½"	18' 2½"	19' 4¼"
28.67	6' 6¾"	8' 2¾"	9' 8¾"	11' 9¾"	12' 5½"	13' 5¾"	16' 6¾"	17' 4¾"
32.77	6' ¾"	7' 2½"	8' 8¼"	10' 9¾"	11' 7¾"	12' 3¾"	15' 1"	16' 7"
36.86	5' 2¾"	6' 6¾"	7' 10¾"	10"	11' 1¾"	11' 7¾"	13' 9¼"	15' 3¼"
40.96	4' 9"	5' 10¾"	7' 5¾"	8' 8¼"	10' 4"	10' 11½"	13' 1¾"	14' 7¾"

External face profile

Box

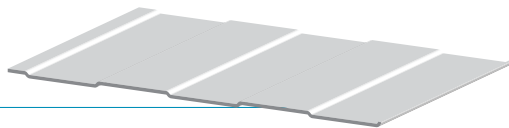

Striated

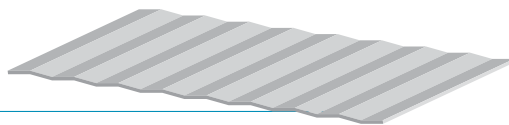

Flat

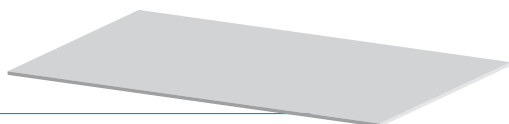

Panel Weight

Steel thickness	PSF	Panel Nominal Thickness (in)							
		1½"	2"	2½"	3"	4"	5"	6"	8"
26/26	PSF	2.07	2.14	2.24	2.33	2.52	2.70	2.89	3.27
24/26	PSF	2.44	2.51	2.61	2.70	2.85	3.04	3.26	3.64
24/24	PSF	2.78	2.85	2.94	3.04	3.22	3.41	3.60	3.97
22/26	PSF	2.72	2.70	2.88	2.98	3.16	3.35	3.54	3.91

Thermal Insulation

R	Panel Nominal Thickness (in)							
	1½"	2"	2½"	3"	4"	5"	6"	8"
75° F Mean Temp (23.9 °C) According to ASTM C518								
m²K/W	2.01	2.48	3.10	3.72	4.96	6.20	7.44	9.92
H ft² F/Btu	11.44	14.08	17.61	21.13	28.17	35.21	42.25	56.34
35° F Mean Temp (1.67 °C) According to ASTM C518								
m²K/W	2.25	2.77	3.46	4.16	5.54	6.93	8.32	11.09
H ft² F/Btu	12.81	15.75	19.69	23.62	31.50	39.37	47.24	62.99

Dimensional Tolerance

Length	L ≤ 9' 10" ± ¼"	Perpendicularity Deviation	¼"
	L > 9' 10" ± ¾"		
Working Length	± 2 mm	Misalignment of the internal metal surfaces	± ⅛"
Thickness	D ≤ 4" ± ¼"	Bottom Sheet Coupling	F = 1 + ⅛"
	D > 4" ± 2%		

L = working length, D = panel thickness, F = sheet coupling

These Span & Load Charts were converted from Metric to Imperial Units. The performance criteria was developed from years of products testing used in ISOPAN Europe / ISOCINDU Central & South America. Actual Load Calculation Requirements are Project specific and must be determined by the Design Team and/or the Structural Engineer of Record. Manni Green Tech will provide assistance, as may be required, to determine the best system for the specific Project Design Requirements. These Charts are for base reference use only.

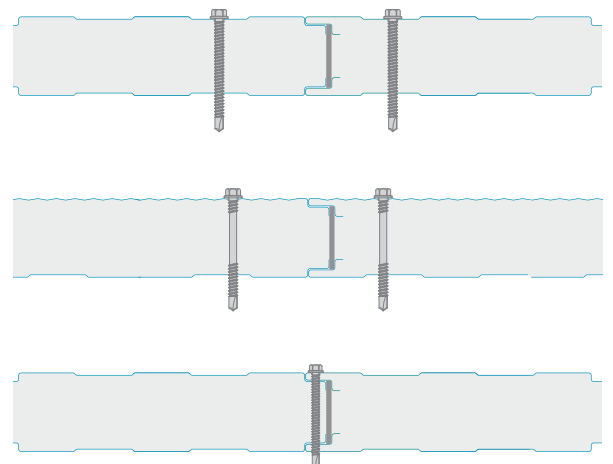

ISOFIRE ROOF

Roof Panel / Isopan production in Europe

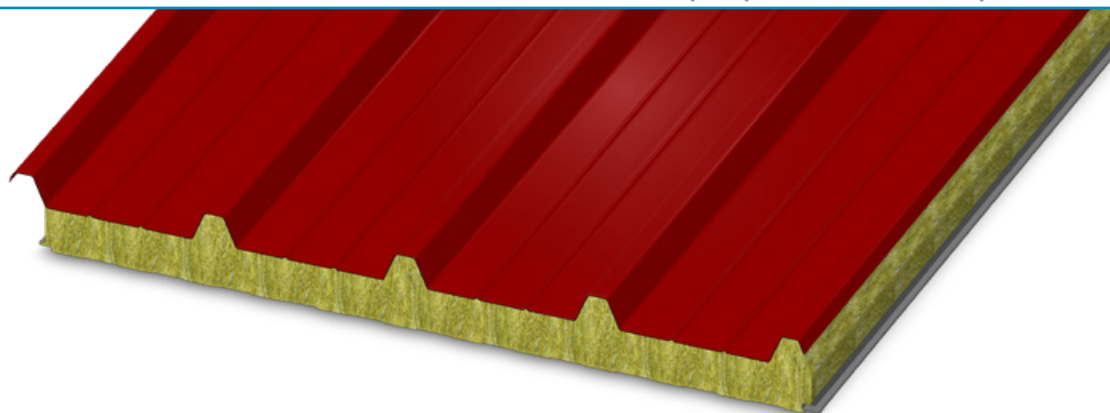

Features

Self-supporting roof panel with double steel sheet and mineral wool core, for roofs with a slope of not less than 7%. 5-ridge profiled external sheet to increase resistance for static and dynamic loads. Visible fastening and clips with gasket.

Options

Isofire Roof is a roofing panel suitable for new construction and renovation of industrial and commercial buildings. The rock wool insulation provides strength and protection in case of fire.

Benefits

- Double sheet metal faced panel
- Fire resistant mineral wool
- Exposed fastening joint
- Ribbed profile for greater strength



Specifications

Standard Length:	Maximum length of 19% (6m)
Width	39 3/8" - 1000 mm
Joint:	Interconnecting male/female
Thickness (m):	50, 60, 80, 100, 120, 150, 170, 200
Exterior Face	Pre-painted Zinc Coated Steel (EN 10346)
Interior Face:	Pre-painted Zinc Coated Steel (EN 10346)
Foam Density:	100 kg/m ³
Exterior Finish:	Polyester coating
Interior Finish:	Polyester coating
Joint Type:	Exposed / Fastening clips

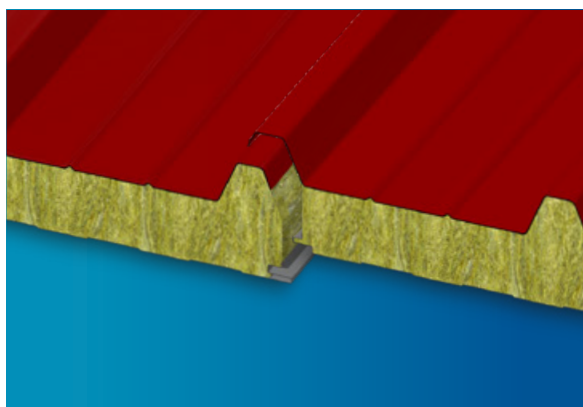

Overload Wheelbase

Kg/m ²	Panel nominal tickness (mm)							
	50	60	80	100	120	150	170	200
Sheets 0,5mm / 0,5mm - Support 120 mm								
80	330	360	420	475	525	550	560	570
100	305	330	375	425	480	495	500	510
120	270	300	345	390	435	475	480	490
140	255	270	315	360	405	420	425	435
160	235	255	290	320	365	390	395	405
180	210	235	270	305	340	360	365	370
200	195	210	255	290	320	340	345	350
220	185	200	240	265	295	325	330	335
250	165	185	215	250	275	290	295	300

Thermal Insulation

According to standard EN 14508 A.10

U	50	60	80	100	120	150	170	200
W/m ² ·K	0.78	0.66	0.50	0.41	0.34	0.28	0.24	0.20
Kcal/m ² ·h·°C	0.67	0.57	0.43	0.35	0.29	0.24	0.21	0.17
K	50	60	80	100	120	150	170	150
W/m ² ·K	0.72	0.61	0.44	0.36	0.30	0.25	0.22	0.19
Kcal/m ² ·h·°C	0.64	0.52	0.38	0.32	0.26	0.22	0.19	0.16

Fire Reaction and Resistance

See page 13 & 14

Overload Wheelbase

Kg/m ²	Panel nominal tickness (mm)							
	50	60	80	100	120	150	170	200
Sheets 0,6mm / 0,6mm - Support 120 mm								
80	350	375	430	495	545	595	605	615
100	315	340	395	445	495	540	550	560
120	280	310	355	405	450	485	490	495
140	260	290	325	370	415	440	445	450
160	245	260	300	340	375	405	410	415
180	230	245	280	315	345	380	385	390
200	210	230	265	300	330	350	355	360
220	195	220	250	280	310	330	335	340
250	170	195	230	260	290	300	305	310

Panel Weight

Steel thickness	50	60	80	100	120	150	170	200
	Values in kg/m ²							
0.5/0.5	14.4	15.4	17.4	19.4	21.4	24.4	26.4	29.4
0.6/0.6	16.2	17.2	19.2	21.2	23.2	26.2	28.2	31.2

Dimensional Tolerance

L = Length, D = Thickness, F = Support

Lenght	L ≤ 3 m ± 5 mm	Perpendicularity Deviation	6 mm
	L > 3 m ± 10 mm		
Working Lenght	± 2 mm	Misalignment of the internal metal surfaces	± 3 mm
Thickness	D ≤ 100 mm ± 2mm	Bottom Sheet Coupling	F = 0 +3 mm
	D > 100 mm ± 2%		

Joint Section

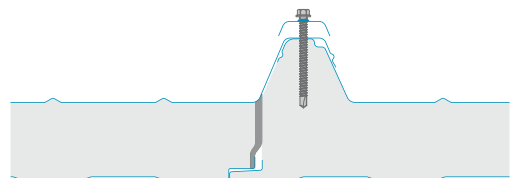

ISOFIRE ROOF FONO

Roof Panel / Isopan production in Europe

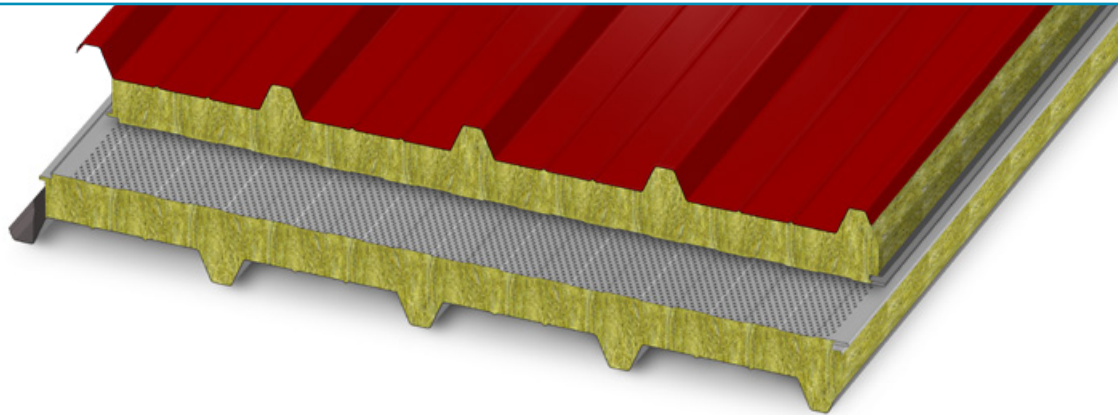

Features

Self-supporting roof panel in double steel sheet and mineral wool core, for roofs with a slope of not less than 7%. External 5-ribbed sheet to increase static and dynamic resistance. Internal micro-perforated steel sheet to increase the acoustic insulation of the panel.

Options

Isofire Roof Fono has an internal micro perforated sheet support capable of increasing the sound absorbing performance of the panel, reducing the decibel level depending on the thickness, ideal for machine rooms or processing rooms.

Benefits

- Double steel sheet faced panel
- Fire resistant rock wool
- Exposed fastening joint
- Ribbed profile for higher strength
- Sound absorbing

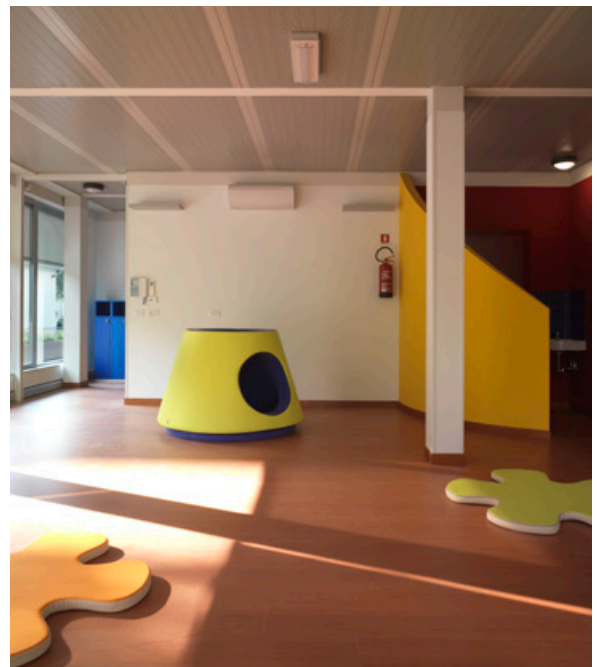

Specifications

Standard Length:	Maximum length of 19% (6m)
Width	39 3/8" - 1000 mm
Joint:	Interconnecting male/female
Thickness (m):	50, 60, 80, 100, 120, 150
Exterior Face	Pre-painted Zinc Coated Steel (EN 10346)
Interior Face:	Micro-perforated steel
Foam Density:	100 kg/m ³
Exterior Finish:	Polyester coating
Interior Finish:	Polyester coating
Joint Type:	Exposed / Fastening clips

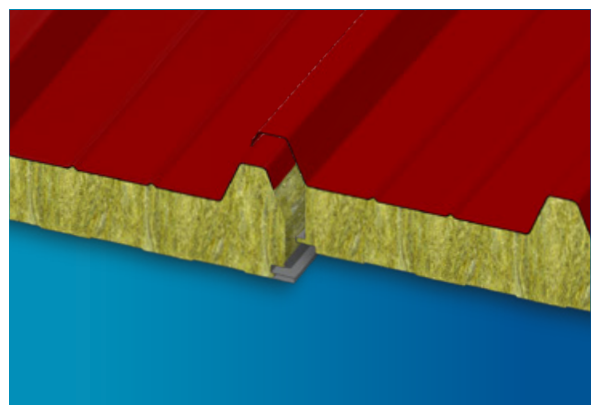

Overload Wheelbase

Kg/m ²	Panel nominal tickness (mm)					
	50	60	80	100	120	150
Sheets 0,5mm / 0,5mm - Support 120 mm						
80	285	310	365	410	455	475
100	265	285	325	365	415	430
120	230	260	300	335	375	410
140	220	230	270	310	350	365
160	200	220	250	275	315	335
180	180	200	230	265	295	310
200	165	180	220	250	275	295
220	160	170	205	230	255	280
250	140	160	185	215	235	250

Thermal Insulation

According to standard EN 14508 A.10

U	50	60	80	100	120	150
W/m ² ·K	0.78	0.66	0.50	0.41	0.34	0.28
Kcal/m ² ·h·°C	0.67	0.57	0.43	0.35	0.29	0.24
K	50	60	80	100	120	150
W/m ² ·K	0.72	0.61	0.44	0.36	0.30	0.25
Kcal/m ² ·h·°C	0.64	0.52	0.38	0.32	0.26	0.22

Fire Reaction and Resistance

See page 13 & 14

Acoustic Behavior

See page 13 & 14

Overload Wheelbase

Kg/m ²	Panel nominal tickness (mm)					
	50	60	80	100	120	150
Sheets 0,6mm / 0,6mm - 120 mm support						
80	300	325	370	430	470	515
100	270	295	340	385	430	465
120	240	265	305	350	390	420
140	225	250	280	320	360	380
160	210	225	260	295	325	350
180	200	210	240	270	300	330
200	180	200	230	260	285	300
220	165	190	215	240	265	285
250	145	165	200	225	250	260

Panel Weight

Steel Thickness	50	60	80	100	120	150
	Values in kg/m ²					
0.5 / 0.5	13.9	14.9	16.9	18.9	20.9	23.9
0.6 / 0.6	15.7	16.7	18.7	20.7	22.7	25.7

Dimensional Tolerance

L = Length, D = Thickness, F = Support

Length	L ≤ 3 m ± 5 mm L > 3 m ± 10 mm	Perpendicularity Deviation	6 mm
Working Length	± 2 mm	Misalignment of the internal metal surfaces	± 3 mm
Thickness	D ≤ 100 mm ± 2mm D > 100 mm ± 2%	Bottom Sheet Coupling	F = 0 +3 mm

Joint Section

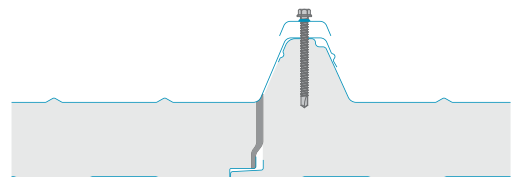
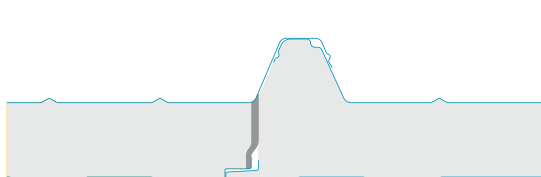

ISOFIRE WALL

Wall Panel / Isopan production in Europe

Striated, Hidden Fastening

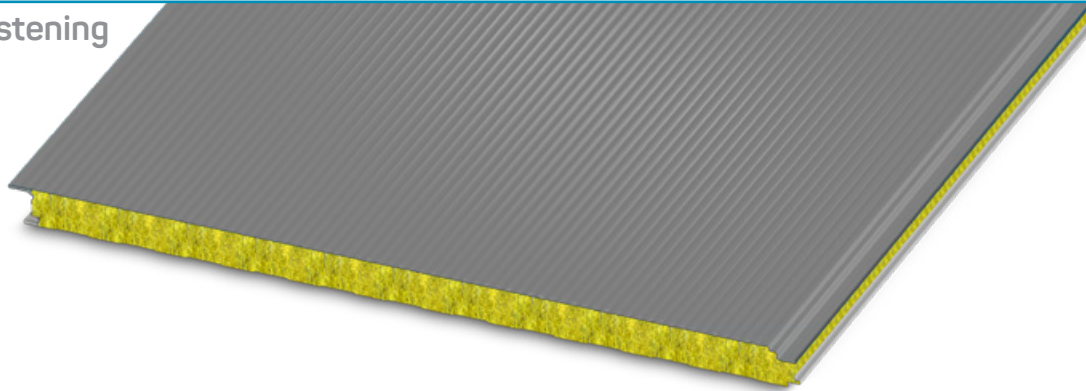

Features

Self-supporting all panel with double steel sheet, mineral wool core and striated external face. Hidden fastening joint with pass-through screw.

Options

Isofire Wall is a insulated metal panel used in industrial and commercial building walls, the striated profile external face offers an architectural finish. The joint is characterized by a hidden fastening system. The mineral wool insulation makes it an excellent fire resistant.

Benefits

- Double sheet metal panel
- Fire resistant rock wool
- Hidden fastening for aesthetic appearance
- Versatility to be installed vertically or horizontally
- Reaction to fire according to A2-S1-D0 class



Specifications

Standard Length:	Maximum length of 19% (6m)
Width	39 3/8" - 1000 mm
Joint:	Interconnecting male/female
Thickness (m):	50, 60, 80, 100, 120, 150, 170, 200
Exterior Face	Pre-painted Zinc Coated Steel (EN 10346)
Interior Face:	Pre-painted Zinc Coated Steel (EN 10346)
Foam Density:	100 kg/m ³
Exterior Finish:	Polyester coating
Interior Finish:	Polyester coating
Joint Type:	Hidden

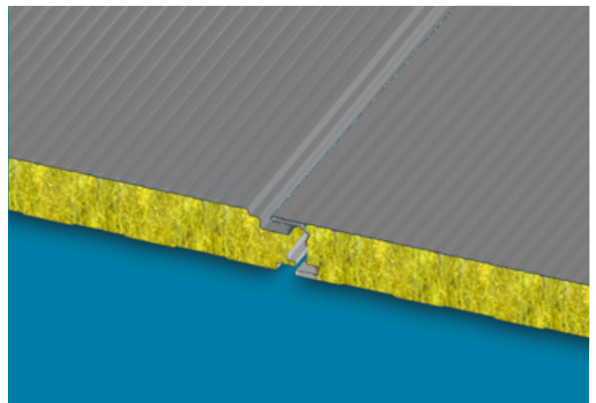

Striated, Hidden Fastening

Overload Wheelbase

Kg/m ²	Panel nominal tickness (mm)							
	50	60	80	100	120	150	170	200
Sheets 0,5mm / 0,5mm - Support 120 mm								
50	440	480	540	610	670	755	805	890
60	390	430	495	570	625	700	750	825
80	310	355	425	500	550	615	650	715
100	250	295	365	440	490	550	580	630
120	210	250	315	385	435	495	525	565
140	180	210	275	340	390	440	475	510
160	160	185	245	300	350	400	435	465
180	145	165	220	270	320	360	395	425
200	130	150	205	250	295	330	360	390
Sheets 0,6mm / 0,6mm - Support 120 mm								
50	490	520	600	675	720	800	860	935
60	425	470	475	635	685	755	810	870
80	335	380	410	550	605	670	720	760
100	265	310	365	460	525	585	630	665
120	235	270	355	410	470	525	560	595
140	200	230	325	360	415	470	505	535
160	175	210	275	315	370	415	445	480
180	160	190	255	275	335	375	405	430
200	140	165	235	255	305	335	365	400

Thermal Insulation

According to standard EN 14508 A.10

U	50	60	80	100	120	150	170	200
W/m ² ·K	0.86	0.72	0.52	0.41	0.35	0.28	0.24	0.20
Kcal/m ² ·h·°C	0.73	0.62	0.44	0.36	0.30	0.24	0.21	0.17
K	50	60	80	100	120	150	170	200
W/m ² ·K	0.75	0.64	0.50	0.40	0.33	0.27	0.24	0.20
Kcal/m ² ·h·°C	0.67	0.55	0.44	0.35	0.30	0.24	0.21	0.17

Panel Weight

Steel thickness	50	60	80	100	120	150	170	200
	Values in kg/m ²							
0.5 / 0.5	13.2	14.2	16.2	18.2	20.2	23.2	25.2	28.2
0.6 / 0.6	14.9	15.9	17.9	19.9	21.9	24.9	26.9	29.9

Joint Section

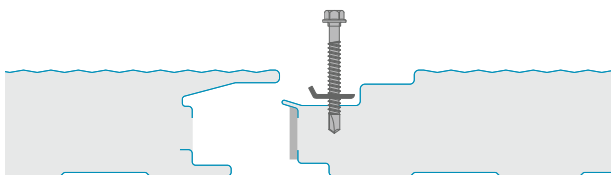

Overload Wheelbase

Kg/m ²	Panel nominal tickness (mm)							
	50	60	80	100	120	150	170	200
Sheets 0,5mm / 0,5mm - Support 120 mm								
50	390	420	460	500	540	580	630	670
60	345	380	415	450	490	520	550	585
80	270	310	345	370	400	425	450	485
100	210	250	285	310	335	355	375	405
120	180	205	240	265	285	305	325	350
140	155	175	210	230	250	265	280	300
160	130	155	185	205	220	230	245	265
180	120	135	165	180	195	205	220	240
200	110	120	150	165	180	190	205	220
Sheets 0,6mm / 0,6mm - Support 120 mm								
50	430	460	500	540	580	610	650	680
60	375	415	455	490	530	560	590	615
80	290	330	375	405	440	465	495	515
100	220	260	300	330	360	380	405	425
120	190	220	250	280	305	325	345	365
140	160	190	220	240	265	280	300	320
160	140	165	195	215	230	245	265	280
180	130	150	175	195	210	225	240	255
200	115	135	160	180	195	210	225	240

Dimensional Tolerance

L = Length, D = Thickness, F = Support

Lenght	L ≤ 3 m ± 5 mm L > 3 m ± 10 mm	Perpendicularity Deviation	6 mm
Working Lenght	± 2 mm	Misalignment of the internal metal surfaces	± 3 mm
Thickness	D ≤ 100 mm ± 2mm D > 100 mm ± 2%	Bottom Sheet Coupling	F = 0 +3 mm

Fire Reaction and Resistance

See page 13 & 14

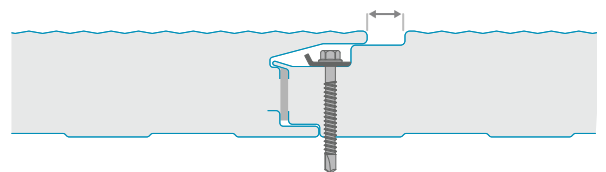

ISOFIRE WALL

Wall Panel / Isopan production in Europe

Exposed Fastening

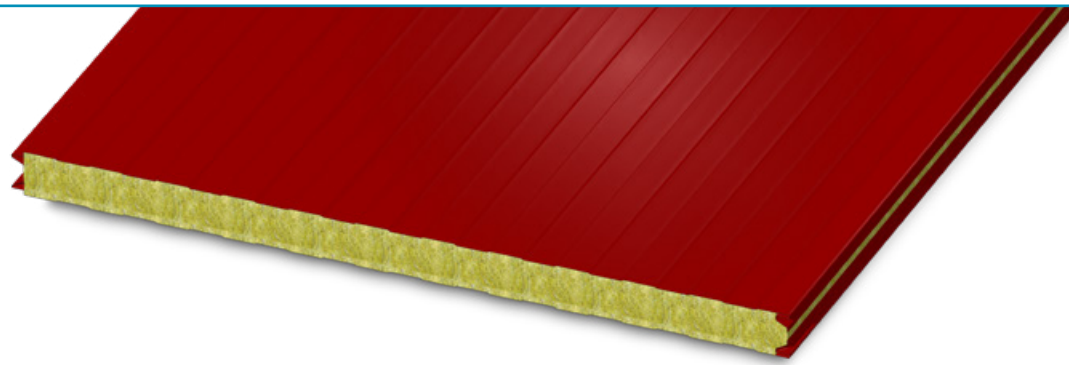

Features

Self-supporting wall panel with double steel sheet and mineral wool core. The tongue-and-groove joint is made by exposed screws and fasteners along the supports.

Options

Isofire Wall is a insulated metal panel used in industrial and commercial building walls. It has tongue-and-groove joints and visible fastening. The mineral wool insulation makes it an excellent fire resistant.

Benefits

- Double sheet metal paneling
- Fire resistant mineral wool
- Versatility to be installed vertically or horizontally
- Reaction to fire according to A2-S1-D0 class

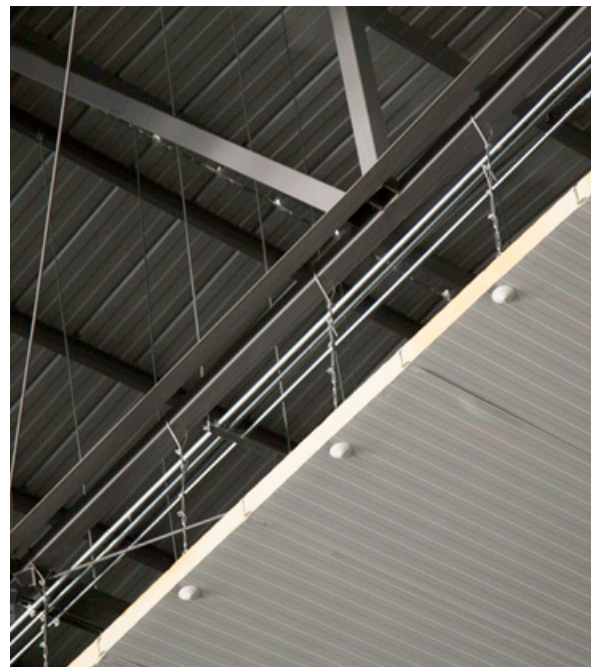

Specifications

Standard Length:	Maximum length of 19¾ (6m)
Width	39 ¾" - 1000 mm
Joint:	Interconnecting male/female
Thickness (m):	50, 60, 80, 100, 120, 150, 170, 200, 240
Exterior Face	Pre-painted Zinc Coated Steel (EN 10346)
Interior Face:	Pre-painted Zinc Coated Steel (EN 10346)
Foam Density:	100 kg/m ³
Exterior Finish:	Polyester coating
Interior Finish:	Polyester coating
Joint Type:	Exposed

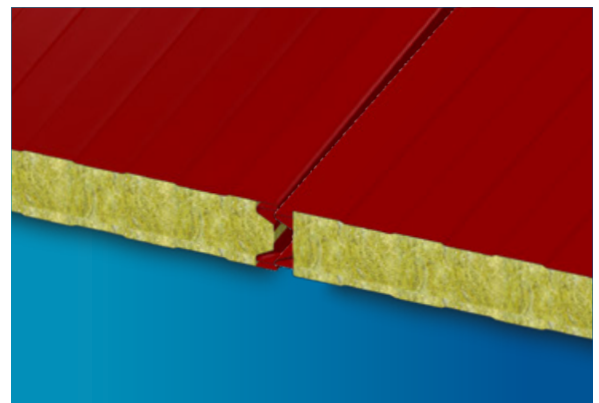

Exposed Fastening

Overload Wheelbase

Kg/m ²	Panel nominal tickness (mm)								
	50	60	80	100	120	150	170	200	240
(Thickness less than 100mm) Sheets 0,5mm / 0,5mm - Support 120 mm									
50	440	480	540	610	670	755	805	890	960
60	390	430	495	570	625	700	750	825	895
80	310	355	425	500	550	615	650	715	770
100	250	295	365	440	490	550	580	630	680
120	210	250	315	385	435	495	525	565	610
140	180	210	275	340	390	440	475	510	550
160	160	185	245	300	350	400	435	465	500
180	145	165	220	270	320	360	395	425	450
200	130	150	205	250	295	330	360	390	415
Sheets 0,6mm / 0,6mm - Support 120 mm									
50	490	520	600	675	720	800	860	935	980
60	425	470	545	635	685	755	810	870	920
80	335	380	465	550	605	670	720	760	820
100	265	310	385	460	525	585	630	665	730
120	235	270	330	410	470	525	560	595	645
140	200	230	290	360	415	470	505	535	570
160	175	210	260	315	370	415	445	480	520
180	160	190	230	275	335	375	405	430	470
200	140	165	210	255	305	335	365	400	430

Thermal Insulation According to standard EN 14508 A.10

U	50	60	80	100	120	150	170	200	240
W/m ² ·K	0.75	0.63	0.49	0.39	0.33	0.27	0.24	0.20	0.17
Kcal/m ² ·h·°C	0.65	0.54	0.42	0.34	0.28	0.23	0.21	0.17	0.15
K	50	60	80	100	120	150	170	200	240
W/m ² ·K	0.75	0.64	0.50	0.40	0.33	0.27	0.24	0.20	0.17
Kcal/m ² ·h·°C	0.67	0.55	0.4	0.35	0.30	0.24	0.21	0.17	0.15

Panel Weight

Steel thickness	50	60	80	100	120	150	170	200	240
	Values in kg/m ²								
0.5 / 0.5	13.2	14.2	16.2	18.2	20.2	23.2	25.2	28.2	32.2
0.6 / 0.6	14.9	15.9	17.9	19.9	21.9	24.9	26.9	28.9	32.9

Joint Section

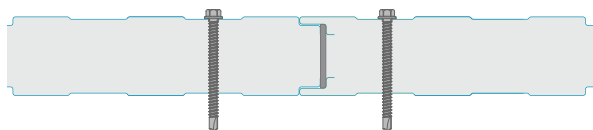

Overload Wheelbase

Kg/m ²	Panel nominal tickness (mm)								
	50	60	80	100	120	150	150	200	200
(Thickness less than 100mm) Sheets 0,5mm / 0,5mm - Support 120 mm									
50	390	420	460	500	540	580	630	670	700
60	345	380	415	450	490	520	550	585	620
80	270	310	345	370	400	425	450	485	520
100	210	250	285	310	335	355	375	405	430
120	180	205	240	265	285	305	325	350	370
140	155	175	210	230	250	265	280	300	320
160	130	155	185	205	220	230	245	265	290
180	120	135	165	180	195	205	220	240	260
200	110	120	150	165	180	190	205	220	240
Sheets 0,6mm / 0,6mm - Support 120 mm									
50	430	460	500	540	580	610	650	680	710
60	375	415	455	490	530	560	590	615	640
80	290	330	375	405	440	465	495	515	545
100	220	260	300	330	360	380	405	425	455
120	190	220	250	280	305	325	345	365	390
140	160	190	220	240	265	280	300	320	340
160	140	165	195	215	230	245	265	280	300
180	130	150	175	195	210	225	240	255	275
200	115	135	160	180	195	210	225	240	260

Dimensional Tolerance L = Length, D = Thickness, F = Support

Lenght	L ≤ 3 m ± 5 mm L > 3 m ± 10 mm	Perpendicularity Deviation	6 mm
Working Lenght	± 2 mm	Misalignment of the internal metal surfaces	± 3 mm
Thickness	D ≤ 100 mm ± 2mm D > 100 mm ± 2%	Bottom Sheet Coupling	F = 0 +3 mm

Fire Reaction and Resistance

See page 13 & 14

ISOFIRE WALL FONO

Wall Panel / Isopan production in Europe

Exposed Fastening

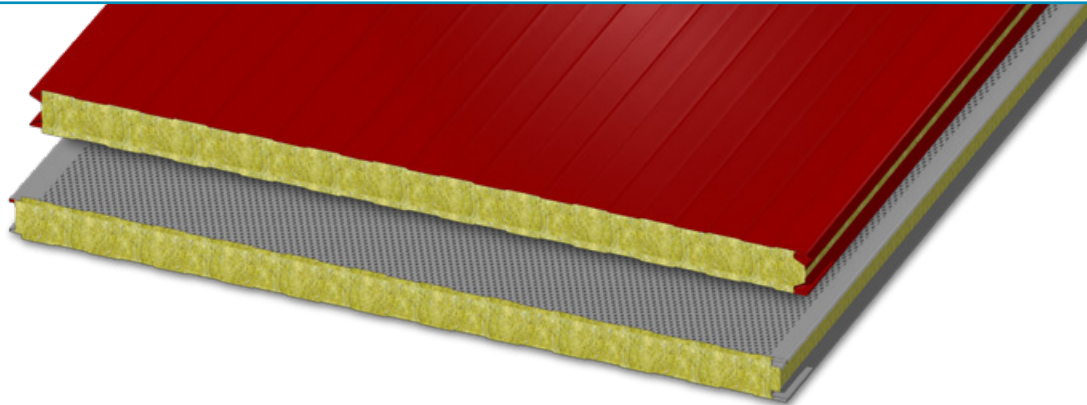

Features

Self-supporting panel of double steel sheet, with mineral wool core. The tongue-and-groove joint is concealed by through-bolts and washers along the supports. The internal micro-perforated steel sheet increases the acoustic insulation of the panel.

Options

Isofire wall fono has an internal support formed by a micro-perforated sheet, with the main function of increasing the sound-absorbing performance of the panel, reducing decibel levels depending on the thickness, ideal for machine rooms or processing rooms.

Benefits

- Fire resistant rock wool
- Concealed fixing for improved aesthetic design
- Can be installed vertically or horizontally
- Fire reaction according to class A2-S1-D0
- Sound absorbing



Specifications

Standard Length:	Maximum length of 19% (6m)
Width	39 3/8" - 1000 mm
Joint:	Interconnecting male/female
Thickness (m):	50, 60, 80, 100, 120, 150
Exterior Face	Pre-painted Zinc Coated Steel (EN 10346)
Interior Face:	Micro-perforated steel
Foam Density:	100 kg/m ³
Exterior Finish:	Polyester coating
Interior Finish:	Polyester coating
Joint Type:	Exposed Fastening

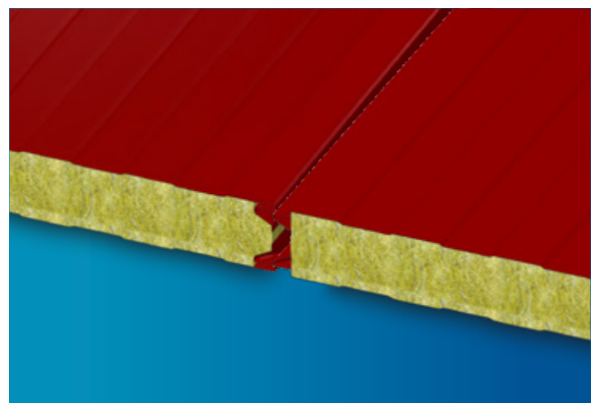

Exposed Fastening

Overload Wheelbase

Kg/m ²	Panel nominal tickness (mm)					
	50	60	80	100	120	150
Sheets 0,5mm / 0,5mm - Support 120 mm						
50	370	400	450	510	560	635
60	325	360	415	475	525	585
80	260	295	355	420	460	515
100	210	245	305	370	410	460
120	175	210	265	320	365	415
140	150	175	230	285	325	370
160	130	155	205	250	290	335
180	120	135	185	225	265	300
200	105	125	170	210	245	275
Sheets 0,6mm / 0,6mm - Support 120 mm						
50	410	435	505	565	605	670
60	355	395	455	535	575	635
80	280	320	390	460	505	560
100	220	260	320	385	440	490
120	195	225	275	345	395	440
140	165	190	240	300	345	395
160	145	175	215	265	310	345
180	130	160	190	230	280	315
200	115	135	175	210	255	280

Thermal Insulation

According to standard EN 14508 A.10

U	50	60	80	100	120	150
W/m ² ·K	0.75	0.63	0.49	0.39	0.33	0.27
Kcal/m ² ·h·°C	0.65	0.54	0.42	0.34	0.28	0.23
K	50	60	80	100	120	150
W/m ² ·K	0.75	0.63	0.50	0.40	0.33	0.27
Kcal/m ² ·h·°C	0.67	0.54	0.44	0.35	0.30	0.24

Panel Weight

Steel thickness	50	60	80	100	120	150
	Values in kg/m ²					
0.5 / 0.5	12.6	13.6	15.6	17.6	19.6	22.6
0.6 / 0.6	13.5	14.5	16.5	18.5	20.5	23.5

Joint Section

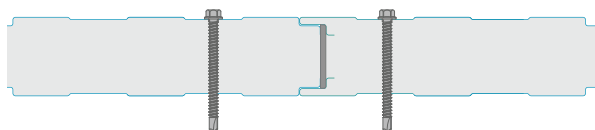

Overload Wheelbase

Kg/m ²	Panel nominal tickness (mm)					
	50	60	80	100	120	150
Sheets 0,5mm / 0,5mm - Support 120 mm						
50	325	350	385	420	455	485
60	290	320	345	375	410	435
80	225	260	290	310	335	355
100	175	210	240	260	280	295
120	150	170	200	220	240	255
140	130	145	175	190	210	220
160	105	130	155	170	185	190
180	100	110	135	150	160	170
200	90	100	125	135	150	160
Sheets 0,6mm / 0,6mm - Support 120 mm						
50	360	385	420	455	485	510
60	315	345	380	410	445	470
80	240	275	315	340	370	390
100	185	215	250	275	300	320
120	160	185	210	235	255	270
140	130	160	185	200	220	235
160	115	135	160	180	190	205
180	105	125	145	160	175	185
200	95	110	130	150	160	175

Dimensional Tolerance

L = Length, D = Thickness, F = Support

Lenght	L ≤ 3 m ± 5 mm L > 3 m ± 10 mm	Perpendicularity Deviation	6 mm
Working Lenght	± 2 mm	Misalignment of the internal metal surfaces	± 3 mm
Thickness	D ≤ 100 mm ± 2mm D > 100 mm ± 2%	Bottom Sheet Coupling	F = 0 +3 mm

Fire Reaction and Resistance

See page 13 & 14

Acoustic Behavior

See page 13 & 14

ANTIBACTERIAL STEEL

Laminated on the basis of plasticized galvanized steel and includes occasional contact

Metallic Coating / PVC Film

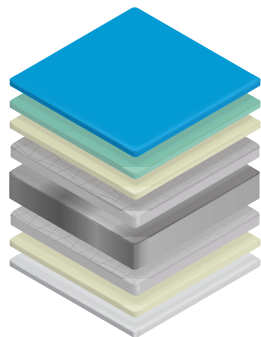

PVC Film

Composition	PVC Film
Applications	Internal perimeter wall, partition wall and ceiling
Substrate	Hot Galvanized Steel, S250 GD (SS33)
Thickness	3.94 until 5.5 mil PVC film
Specular Brightness (60°):	15 - 45 GU
Surface appearance	Smooth
Corrosion resistance	●●●●○
Moisture resistance	●●●●○
Exercise temperatures	60°C

Properties: PVC Film

Test	Result
Coating Adhesion (T-Bend)	≤ 2 T
Crack Resistance (T-Bend)	≤ 3 T
Impact resistance	18 J
Pencil hardness	HB
Corrosion Resistance (Salt Spray Test)	360 hrs
Condensation Resistance (QCT Test)	1000 hrs
Resistance to acids and bases	Good
Solvent resistance: Aliphatics and alcohols	Good
Solvent resistance: Ketones	Low
Solvent resistance: Aromatic	Good
Mineral oil resistance	Very Good

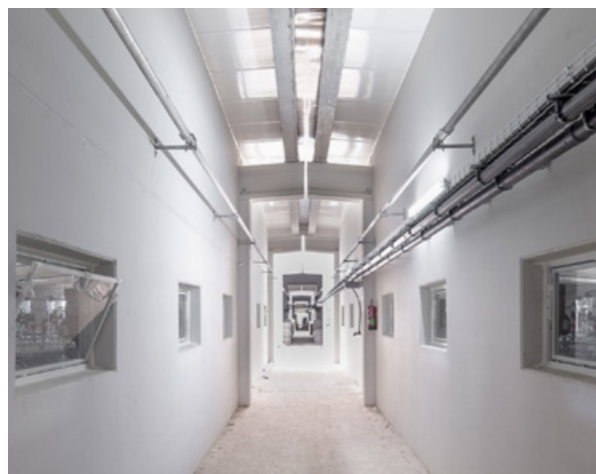

The sheet is certified according to ISO 22196:2007, ASTM E 2180-07, JIS Z 2801 and EN 13501-1. The antibacterial property develops throughout the thickness of the coating film and the efficacy is proven against the following types of bacteria: *Escherichia Coli*; *Klebsiella pneumoniae*; *Staphylococcus aureus*; *Salmonella typhimurium*; *Listeria monocytogenes*; *Legionella pneumophila*; *Pseudomonas aeruginosa*.

In addition, the product is certified for occasional contact with food in accordance with 2002/72/EC and successive updates.

Antibacterial test (JIS Z2801 and ISO22196: 2011)

Bacterial Strain	Bacteria Reduction(%)
<i>Escherichia Coli</i> ATCC8739	≥ 99,9
<i>Klebsiella Pneumoniae</i> ATCC4352	≥ 99,9
<i>Salmonella Enterica</i> ATCC1307	≥ 99,9
<i>Listeria Monocytogenes</i> ATCC15313	≥ 99,9
<i>Pseudomonas Aeruginosa</i> ATCC15442	≥ 99,9
<i>Enterococcus Faecium</i> ATCC6057	≥ 99,9
<i>Staphylococcus Aureus</i> MRSA ATCC33592	≥ 99,9

USDA STEEL

USDA standard polyester for occasional contact with food

Metallic Coatings / Standard Polyester

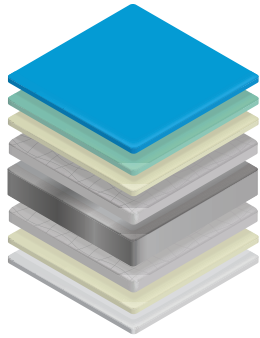

Standard Polyester

Composition	PE Estándar
Applications	Internal perimeter wall, partition wall and ceiling
Substrate	HDG
Thickness	25 µm
Composition	0.20 mil primer + 0.8 mil finishing layer
Specular Brightness (60°)	25 - 35 GU
Surface appearance	Smooth
Corrosion resistance	● ● ○ ○ ○
Moisture resistance	● ● ● ○ ○

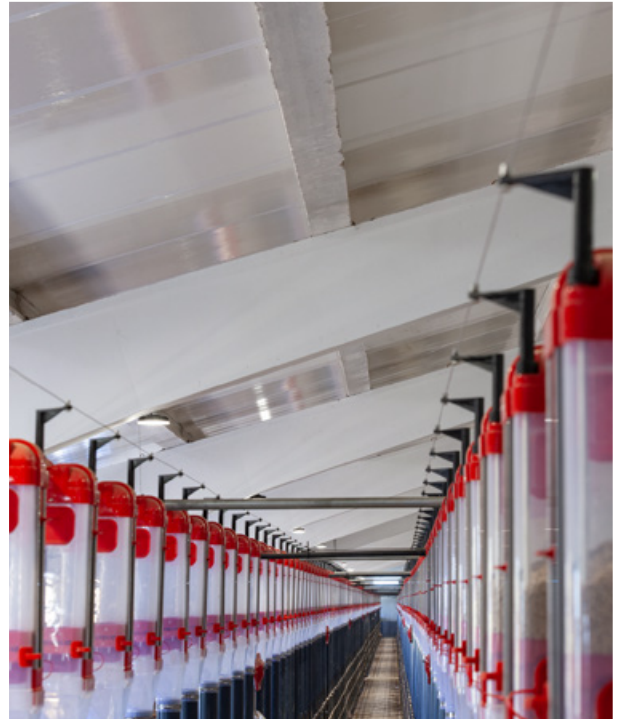

Product formulated with flex formula color raw materials, as established by USDA.

Occasional contact with food.

Properties: Standard Polyester

Test	Result
Flexibility, NTO	0T - 2T
Pencil Hardness	F - 2H
Solvent Rubs (MEK)	100+
Reverse Impact (IN-LB NTP)	100 - 160

Test	Result
Viscosity 25° C ZAHN#4	20 - 25 ASTM D4212-93
KG/L	1.32 - 1.38 ASTM D1475-90
Non volatile by weight	68 - 72 ASTM D2369-95
Non volatile by volume	52 - 56 ASTM D2697-86
Fineness (Hegman)	6.0 - 8.0 ASTM D1210-79

STAINLESS STEEL

Benefits of Stainless Steel

- ▶ Durable, hygienic and low maintenance
- ▶ Great aesthetic and decorative value
- ▶ Easy to weld, adjustable and foldable
- ▶ Impact and scratch resistant
- ▶ Great mechanical resistance
- ▶ Resistant to water, steam and humidity
- ▶ Resists food acids
- ▶ Resists weak organic and inorganic acids
- ▶ Maintains the organoleptic properties of food
- ▶ Ideal for food, pharmaceutical and cosmetic industries
- ▶ Resistant to corrosion and temperature changes
- ▶ Recyclable material
- ▶ Retains its appearance throughout its useful life and installation
- ▶ Allows glossy, matte and polished finishes

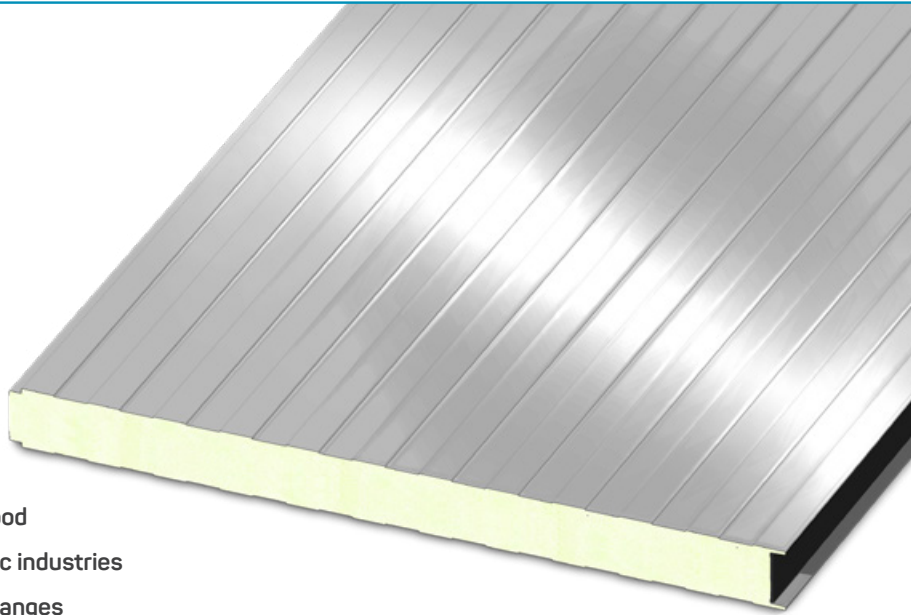

Chemical composition Euronorm 10088 : 1.4301 / AISI: 204

	C	Si	Mn	P	S	Cr	Ni	N	Cu
Min	0	0.30	1.00	0	0	18.0	8	.055	0
Max	0.03	0.50	1.80	0.04	.007	18.4	8.5	.065	0
Final	0.08	0.45	1.30	0.03	.005	18.2	8.5	.055	0

Mechanical Characteristics

	Performance 0,2% - N/mm ²	Stress N/mm ²	Stretching L=80mm	HRB	Bend	I.E
Min	280	550	50	78	Bueno	Bueno
Max	380	750	55	88		
Final	310	640	55	80		

Dimensional Tolerance

	Thickness <0.49	Tolerance ±0.03
0.5	0.69	± 0.04
0.7	1	± 0.05
1.01	1.49	± 0.06
1.5	1.8	± 0.07
1.81	2	± 0.08
2.01	2.5	± 0.10
2.51	3	± 0.11
3.01	5	± 0.15

Sheets

Length	Tol. Width mm	Tol. Plane mm	Tol. Squad mm
250 - 2000	-0, +4	< 2.0	< 2
2001 - 4000	-0, +6	< 3.5	< 4
4001 - 6000	-0, +8	< 6.0	< 6
6001 - 8000	-0, +10	< 6.0	< 8

Coils

	Width of thickness	Tolerance
<150	<1,75	-0, +0.3
	1,75 - 3,00	-0, +0.4
	3,00 - 5,00	-0, +0.5
151 - 230	<1,75	-0, +0.3
	1,75 - 3,00	-0, +0.5
	3,00 - 5,00	-0, +2.0
231 - 609	<3,00	-0, +0.5
	3,01 - 5,00	-0, +2.0
610 - 1524	<3,00	-0, +1.5
	3,01 - 5,00	-0, +2.0

Finish	Std	ra (micron)	Gloss	Notes
2B	xxx	0.20 - 0.50		Formability: Standard grade 304, used for 95% of applications, for the remaining 5% 204 dd
BA	x	0.30 - 0.05	> 50%	Corrosion resistance: 304 can be used for any purpose other than in contact with CL ion
Polished f4	xxx	1.00 - 1.25		Welding: 304 can be used for general use.
Brushed	xxx	0.10 - 0.25		Yield: The s.g of 304 is 8.07 Kg / m ² / mm

STAINLESS STEEL

Specifications

Part number
Application
Steel Type (AISI)
Thickness (mm)
T. Tolerances (mm)
Width (mm)
W. Tolerances (mm)
Lenght (mm)
L. Tolerances (mm)
Quantity
Finishing
Roughness Range
Finish Direction
Slitter - Mill/Slitted
PVC Paperless
Plastic Type
Film Reserve
Packing
Internal Diameter (Coil)
Vertical/Horizontal Side
Min/Max Weight
Min/Max Pieces

0.50mm (26 size)

3040510602B	3040511452B
Polyurethane Panel	✓
304	✓
0.50mm (size 26)	✓
+ / - 0.03	✓
1060 mm	1145 mm
-0 / +2 mm	✓
N/A	✓
N/A	✓
Roll 3-5 tons	✓
Face A: 2B / Face B: Polish Grain 80	✓
R.R min 80 max 100	✓
Parallel to Width	✓
No	✓
Paper	✓
No	✓
N/A	✓
Standard	✓
508 mm with Cardboard Center	✓
Horizontal	✓
3 tons	✓
N/A	✓

PANEL THICKNESS CALCULATION

Panel Thickness vs. Thermal Differential Calculation / PUR and PIR

Delta C°	Thermal Losses W/M² C																		
	3	4	5	6	7	8	9	10	11	12	13	14	15	16	17	18	19	20	
								8"				6"		5"					
91	0.033	0.044	0.055	0.066	0.077	0.088	0.099	0.110	0.121	0.132	0.143	0.154	0.165	0.176	0.187	0.198	0.209	0.220	4"
90	0.033	0.044	0.056	0.067	0.078	0.089	0.100	0.111	0.122	0.133	0.144	0.156	0.167	0.178	0.189	0.200	0.211	0.222	
85	0.035	0.047	0.059	0.071	0.082	0.094	0.106	0.118	0.129	0.141	0.153	0.165	0.176	0.188	0.200	0.212	0.224	0.235	
80	0.038	0.050	0.063	0.075	0.088	0.100	0.113	0.125	0.138	0.150	0.163	0.175	0.188	0.200	0.213	0.225	0.238	0.250	
75	0.040	0.053	0.067	0.080	0.093	0.107	0.120	0.133	0.147	0.160	0.173	0.187	0.200	0.213	0.227	0.240	0.253	0.267	
70	0.043	0.057	0.071	0.086	0.100	0.114	0.129	0.143	0.157	0.171	0.186	0.200	0.214	0.229	0.243	0.257	0.271	0.286	3"
65	0.046	0.062	0.077	0.092	0.108	0.123	0.138	0.154	0.169	0.185	0.200	0.215	0.231	0.246	0.262	0.277	0.292	0.308	
60	0.050	0.067	0.083	0.100	0.117	0.133	0.150	0.167	0.183	0.200	0.217	0.233	0.250	0.267	0.283	0.300	0.317	0.333	2.5"
55	0.055	0.073	0.091	0.109	0.127	0.145	0.164	0.182	0.200	0.218	0.236	0.255	0.273	0.291	0.309	0.327	0.345	0.364	
50	0.060	0.080	0.100	0.120	0.140	0.160	0.180	0.200	0.220	0.240	0.260	0.280	0.300	0.320	0.340	0.360	0.380	0.400	2"
45	0.067	0.089	0.111	0.133	0.156	0.178	0.200	0.222	0.244	0.267	0.289	0.311	0.333	0.356	0.378	0.400	0.422	0.444	
40	0.075	0.100	0.125	0.150	0.175	0.200	0.225	0.250	0.275	0.300	0.325	0.350	0.375	0.400	0.425	0.450	0.475	0.500	1.5"
35	0.086	0.114	0.143	0.171	0.200	0.229	0.257	0.286	0.314	0.343	0.371	0.400	0.429	0.457	0.486	0.514	0.543	0.571	1.5"
30	0.100	0.133	0.167	0.200	0.233	0.267	0.300	0.333	0.367	0.400	0.433	0.467	0.500	0.533	0.567	0.600	0.633	0.667	1"
25	0.120	0.160	0.200	0.240	0.280	0.320	0.360	0.400	0.440	0.480	0.520	0.560	0.600	0.640	0.680	0.720	0.760	0.800	
20	0.150	0.200	0.250	0.300	0.350	0.400	0.450	0.500	0.550	0.600	0.650	0.700	0.750	0.800	0.850	0.900	0.950	1.000	
15	0.200	0.267	0.333	0.400	0.467	0.533	0.600	0.667	0.733	0.800	0.867	0.933	1.000	1.067	1.133	1.200	1.267	1.333	
10	0.300	0.400	0.500	0.600	0.700	0.800	0.900	1.000	1.100	1.200	1.300	1.400	1.500	1.600	1.700	1.800	1.900	2.000	
5	0.600	0.800	1.000	1.200	1.400	1.600	1.800	2.000	2.200	2.400	2.600	2.800	3.000	3.200	3.400	3.600	3.800	4.000	

	Panel Nominal Thickness (in)										
	1"	1½"	1½"	1½"	2"	2½"	3"	4"	5"	6"	8"
U	PUR & PIR / 35 ° F (1.67 ° C) 55°F a 15°F / ASTM C518										
W/m²·K	0.880	0.704	0.586	0.541	0.440	0.352	0.293	0.220	0.176	0.147	0.110
Btu/H·ft²·F	0.155	0.124	0.103	0.095	0.077	0.062	0.052	0.039	0.031	0.026	0.019
R	PUR & PIR / 35 ° F (1.67 ° C) 55°F a 15°F / ASTM C518										
m²/K/W	1.137	1.421	1.705	1.848	2.274	2.842	2.842	4.548	5.685	6.822	9.095
H ft/F/Btu	6.456	8.070	9.684	10.912	12.912	16.139	16.139	25.823	32.279	38.735	51.646

PANEL THICKNESS CALCULATION

Panel Thickness vs. Thermal Differential Calculation / PIR LEAF

Delta C°	Thermal Losses W/M² C																		
	3	4	5	6	7	8	9	10	11	12	13	14	15	16	17	18	19	20	
						8"		6"		5"			4"					3"	
91	0.033	0.044	0.055	0.066	0.077	0.088	0.099	0.110	0.121	0.132	0.143	0.154	0.165	0.176	0.187	0.198	0.209	0.220	
90	0.033	0.044	0.056	0.067	0.078	0.089	0.100	0.111	0.122	0.133	0.144	0.156	0.167	0.178	0.189	0.200	0.211	0.222	
85	0.035	0.047	0.059	0.071	0.082	0.094	0.106	0.118	0.129	0.141	0.153	0.165	0.176	0.188	0.200	0.212	0.224	0.235	
80	0.038	0.050	0.063	0.075	0.088	0.100	0.113	0.125	0.138	0.150	0.163	0.175	0.188	0.200	0.213	0.225	0.238	0.250	
75	0.040	0.053	0.067	0.080	0.093	0.107	0.120	0.133	0.147	0.160	0.173	0.187	0.200	0.213	0.227	0.240	0.253	0.267	
70	0.043	0.057	0.071	0.086	0.100	0.114	0.129	0.143	0.157	0.171	0.186	0.200	0.214	0.229	0.243	0.257	0.271	0.286	
65	0.046	0.062	0.077	0.092	0.108	0.123	0.138	0.154	0.169	0.185	0.200	0.215	0.231	0.246	0.262	0.277	0.292	0.308	
60	0.050	0.067	0.083	0.100	0.117	0.133	0.150	0.167	0.183	0.200	0.217	0.233	0.250	0.267	0.283	0.300	0.317	0.333	
55	0.055	0.073	0.091	0.109	0.127	0.145	0.164	0.182	0.200	0.218	0.236	0.255	0.273	0.291	0.309	0.327	0.345	0.364	
50	0.060	0.080	0.100	0.120	0.140	0.160	0.180	0.200	0.220	0.240	0.260	0.280	0.300	0.320	0.340	0.360	0.380	0.400	
45	0.067	0.089	0.111	0.133	0.156	0.178	0.200	0.222	0.244	0.267	0.289	0.311	0.333	0.356	0.378	0.400	0.422	0.444	
40	0.075	0.100	0.125	0.150	0.175	0.200	0.225	0.250	0.275	0.300	0.325	0.350	0.375	0.400	0.425	0.450	0.475	0.500	
35	0.086	0.114	0.143	0.171	0.200	0.229	0.257	0.286	0.314	0.343	0.371	0.400	0.429	0.457	0.486	0.514	0.543	0.571	
30	0.100	0.133	0.167	0.200	0.233	0.267	0.300	0.333	0.367	0.400	0.433	0.467	0.500	0.533	0.567	0.600	0.633	0.667	
25	0.120	0.160	0.200	0.240	0.280	0.320	0.360	0.400	0.440	0.480	0.520	0.560	0.600	0.640	0.680	0.720	0.760	0.800	
20	0.150	0.200	0.250	0.300	0.350	0.400	0.450	0.500	0.550	0.600	0.650	0.700	0.750	0.800	0.850	0.900	0.950	1.000	
15	0.200	0.267	0.333	0.400	0.467	0.533	0.600	0.667	0.733	0.800	0.867	0.933	1.000	1.067	1.133	1.200	1.267	1.333	
10	0.300	0.400	0.500	0.600	0.700	0.800	0.900	1.000	1.100	1.200	1.300	1.400	1.500	1.600	1.700	1.800	1.900	2.000	
5	0.600	0.800	1.000	1.200	1.400	1.600	1.800	2.000	2.200	2.400	2.600	2.800	3.000	3.200	3.400	3.600	3.800	4.000	

	Panel Nominal Thickness (in)										
	1"	1½"	1½"	1½"	2"	2½"	3"	4"	5"	6"	8"
U	PIR LEAF / 35 °F (1.67 °C) 55°F a 15°F / ASTM C518										
W/m²·K	0.628	0.502	0.419	0.386	0.314	0.251	0.209	0.157	0.126	0.105	0.079
Btu/H·ft²·F	0.111	0.088	0.074	0.068	0.055	0.044	0.037	0.028	0.022	0.018	0.014
R	PIR LEAF / 35 °F (1.67 °C) 55°F a 15°F / ASTM C518										
m²K/W	1.592	1.990	2.388	2.588	3.185	3.981	4.777	6.639	7.962	9.554	12.739
H ft/F/Btu	9.04	11.302	13.562	14.693	18.083	22.604	27.125	36.166	45.208	54.250	72.333

PORTFOLIO

Some reference projects



Mexico



Austria



Italy



Romania



Russia



Mexico

PORTFOLIO



México



Mexico



Mexico



Portugal



Mexico



Mexico

For more projects visit our website www.isocindu.com or ask your sales rep.



M

PART OF
MANNI
GROUP



isocindu

BUILDING ENVELOPE SOLUTIONS
Cindu - Manni Group J.V.

ISOCINDU MÉXICO

Av. Libre Comercio #137
Puerto Interior Santa Fe III
Silao Gto. C.P. 36275

T. +52 472 800 7241

MANNI GREEN TECH USA

179 Hughes Landing Blvd
Suite 400, The woodlands TX
TX 77398

T. (281) 747-5588

MANNI GREEN TECH USA

77530 Enfield Lane,
Building D, Suite D2,
Palm Desert, California, 92211

T. (281) 747-5588

ISOPAN IBERICA

Terragona | Spain

ITALY

ISOPAN SPA

Verona | Italy
Frosinone | Italy

ISOPAN EST

Popești Leordeni | Romania

ISOPAN Manni Group CZ

Praha | Czech Republic

ISOPAN FRANCE

Mérignac | France



www.isocindu.com / atencionclientes@isocindu.mx